



CENTRAL INSTITUTE OF MEDICINAL AND AROMATIC PLANTS
(Council of Scientific and Industrial Research)
Post Office-CIMAP, Lucknow-226015

Name of Work: **Replacement of the LT panel board of 3rd phase lab. Building, TPN - MCB DB's panel of the 2nd phase lab. Building, replacement of old cables and installation of additional feeder pillar etc. at CSIR CIMAP Lucknow.**

CONTENTS

SI No.	Description	No. of pages
1.	Contents	1-2
2.	Notice inviting Tenders	3- 6
4.	Appendix	7- 8
5.	Contract Document for work	6 pages + 23 pages
6.	Abstract of cost / Part –II - Price Bid Schedule of quantities a) Building work b) Electrical work	- 39 - 44
7	Drawings	45- 53
8.	General specifications for: A) Building work B) Water supply and sanitary installations C) Electrical work	Latest CPWD Specification will be applicable

Note:

1. Tenderes should confirm that they have received all the above papers from S. No. 1 to 7.
2. Particulars at Sl. No. 8 may be seen in the Engineering Unit. Post office – CIMAP, Lucknow 226015 between the hours of 11.00 A.M. to 4.00 P.M. on any working day.

M/s.....

Received Rs. _____ (Rupees _____) only in cash vide Challan no. _____ dated _____ from M/s _____ towards **cost of the tender documents**

Signature of the Tender Issuing Officer

Crossed Demand Draft/ Bankers cheque from a Nationalized Bank for Rs. _____ (Rupees _____) drawn on _____ is enclosed with the tender towards **cost of Tender paper.**

Signature of the Tenderer

Name of the Tenderer

Seal of the Tenderer



Particulars of Earnest Money

Crossed Demand Draft for **Rs28,100.00 (Rupees Twenty eight thousand one hundred only)**
Drawn on the
Has been sent to the officer opening the tenders.

Or

In other forms as specified in condition no. 9 of notice inviting tender

Tender issued to: Dated:

M/s
.....
.....

Signature of Tenderer

telephone No., if any)

Credential verified/tender issued subject to verification of credentials.

**Signature of the Officer
issuing Tender**

Cash Receipt No.

Dated for Rs.



**Central Institute of Medicinal and Aromatic Plants
(Council of Scientific and Industrial Research)**

NOTICE INVITING TENDER

Sealed tenders are hereby invited in “Two Bid system” **Technical bid and Financial bid** for the work : **Replacement of the LT panel board of 3rd phase lab. Building, TPN - MCB DB’s panel of the 2nd phase lab. Building, replacement of old cables and installation of additional feeder pillar etc. at CSIR CIMAP Lucknow** from ‘A’ class approved electrical contractors of CPWD, State PWDs, Railway or MES, Public undertakings, UPPCL, registered for carrying out Electrical work from those who have carried out similar works for CSIR, Govt and Semi government organizations or Public Sector Undertaking Institutions etc. Tenderers should have successfully completed at least three work amounting to 40% **(Rs 5.62 Lakhs)** or two works of **50% (Rs. 7.02Lakhs)** or at least one work amounting to **80% (Rs11.23 Lakhs)** value of the estimated cost or above in single contract during the last five year. Tenders will be issued to only those contractors who show the satisfactory work completion certificates and proof of their registration under works contract tax, etc.

1. Estimated cost is **Rs14.03 Lakhs (based on market rate & CPWD. D.S.R - 2013)**
2. Time for carrying out the work will be **Four Months.**
3. The tender will be in two bid system. Cover – I - shall be super scribed as “Technical Bid” and shall contain the following:
 - i) Tender fee of Rs500.00 (Non refundable) } Separate Demand Draft drawn in favor of
 - ii) EMD of Rs28,100.00 (Bank Draft) } Director, CSIR – CIMAP, Lucknow.
 - iii) Requisite experience proof along with certificate regarding satisfactory completion of work.
 - iv) Registration certificate under work contract tax.
 - v) Copy of pan card.
 - vi) Duly filled and signed Tender documents except pries bid.
 - vii) Character certificate from District Magistrate not more than one year old or Tenderer has to submit a valid Character Certificate in the form of an Affidavit on the stamp paper of Rs.100/- to the effect that the contractor/firm has not been blacklisted by any Govt. deptt /CSIR as also that there is no criminal case pending against the firm/contractor in any court of Law.
 - viii) A copy of partnership deed, in case of partnership firms.
 - ix) Valid ‘A’ Class Electrical License of the Contractor / Sub Contractor (Issued by the Electric Safety Department).

Cover – II should be super scribed as “Financial bid” and should be contain only the contractor’s quoted rates in the enclosed format. Cover –II will be opened only if the Institute is satisfied with the Technical bid which will be opened first. Any type of correction, overwriting or erasing will lead to disqualification of the tender. Both the cover –I & cover - II may be



placed and submitted in another wax sealed cover super scribed **“Replacement of the LT panel board of 3rd phase lab. Building, TPN - MCB DB’s panel of the 2nd phase lab. Building, replacement of old cables and installation of additional feeder pillar etc. at CSIR CIMAP Lucknow ”** and addressed to the **Director, CSIR-Central Institute of Medicinal and Aromatic Plants, Post office CIMAP, Lucknow- 226015**. Institute will not be responsible for any postal delays etc.

Before submitting the tender please go through all the terms and conditions on which the work will be awarded and to be executed by the successful tenderer. Tender documents shall be issued during office hours in the office of **Controller of Administration, CIMAP, CENTRAL INSTITUTE OF MEDICINAL AND AROMATIC PLANTS , Post office CIMAP, Lucknow-226015 from 22.10.2014 to 31.10.2014** on cash payment of **Rs500.00 (Rupees Five Hundred only)** or Tender papers along with terms & conditions can be downloaded from the institute web site; www.cimap.res.in and the duly completed tenders may be dropped in the tender box kept in the office of **Controller of Administration, CSIR - CIMAP, CENTRAL INSTITUTE OF MEDICINAL AND AROMATIC PLANTS, Post office CIMAP, Lucknow-226015** in a wax sealed cover super scribed **“Replacement of the LT panel board of 3rd phase lab. Building, TPN - MCB DB’s panel of the 2nd phase lab. Building, replacement of old cables and installation of additional feeder pillar etc. at CSIR CIMAP Lucknow”** up to **2.30 P.M. on dated: 03.11.2014** and **Technical bid** will be opened at **3.30 PM** on the same day in the presence of the tenderers or their authorized representative, present if any. The opening date of financial bids of the successful technical bidders will be intimated by post / Telephone.

4. Contract document consisting of the details plans, complete specifications and the set of schedule of quantities and the various conditions of contract to be complied with by the persons whose tenders may be accepted, which will also be found printed in the form of tenders, can be seen in the office of **Engg. Unit/ Controller of Administration, Central Institute of Medicinal and Aromatic Plants, P.O. CIMAP, Lucknow-226015** between the hours of 11.00 A.M. and 4.00 P.M. on any working day.
5. Tenders and / or earnest money receipts or demand drafts received up to 2.30 P.M. on **03.11.2014** whether sent by poster delivered in person are liable to be rejected.
6. Tenders should be submitted in double sealed covers with the name of the work written both on the inner and outer envelopes. They will be received upto 2.30 P.M. on **03.11.2014** and **Technical bid** will be opened at 3.30 P.M. on the same day at **Central Institute of Medicinal and Aromatic Plants, (CIMAP), Lucknow-226015**. tender forms will be issued from **22.10.2014 to 31.10.2014**.



7. Tenders should be on the specified form which may be obtained from office of the **Controller of Administration, Central Institute of Medicinal and Aromatic Plants, P.O. CIMAP, Lucknow-226015** on payment in cash of **Rs. 500/- (Rupees Five Hundred only)** in the favor of the **Director, Central Institute of Medicinal & Aromatic Plants, Lucknow** or can be downloaded from the institute web site; www.cimap.res.in. The cost of tender papers is not refundable under any circumstances.
8. The contractors should quote in figures as well in words the rates and amount tendered by them. The amount for each item should be worked out and the requisite totals given.
9. The earnest money amounting to **Rs28,100.00 (Rupees Twenty eight thousand one hundred only)** should be deposited by Demand Draft drawn in favor of the **Director, CIMAP Lucknow** issued by a Scheduled Bank. **The earnest money , technical bid and financial bid should be put up in the separate – separate sealed envelopes , which can be kept in one bigger sealed cover.** All tenders which are received without earnest money, will not be accepted.
10. Tenders should be sent in double sealed cover to the **Controller of Administration, Central Institute of Medicinal and Aromatic Plants, P.O. CIMAP, Lucknow-226015**. The words Tender for the work due date **03.11.2014** up to 2.30 P.M. shall be written by contractors both on the outer and inner envelopes.
11. The Council of Scientific and Industrial Research does not bind itself to accept the lowest tender and reserves to itself the authority to reject any or all of the tenders received without assigning any reasons.
12. Canvassing in connection with the tenders is strictly prohibited and the tenders submitted by the contractors who resort to canvassing will be liable to rejection on the same ground.
13. Tenders incorporating additional conditions are liable to be rejected.
14. The tenderer shall not be permitted to tender for works in the concerned unit of CSIR in which a relative is posted in the grade between Controller of Administration and Junior Engineer, (both inclusive). He shall also intimate the names of persons who are working with him in any capacity or subsequently employed by him and who are relatives as mentioned above.
15. SALES TAX or any other tax or duties on material in respect of their contract will be payable by the contractor and nothing extra will be payable for increase in such taxes or duties even if imposed or levied either before or after the tenders are opened or during the currency of the contract. WCT shall be deducted at source from bill as applicable in the state.
16. Item rate tenders showing percentage above or below are liable to be rejected.



17. Earnest money is liable to be forfeited, if the contractor selected for the work fails to send necessary stamp paper or to sign the formal agreement within seven days from the date of intimation to that effect to him or fails to start the work within seven days from date of commencement given in the work order.
18. Name of address of the officer
To whom earnest money / receipts/drafts
Are to be sent, along with original tender
The Director
Central Institute of
Medicinal & Aromatic Plants,
Lucknow-226015
19. Tender which do not fulfill all or any of the above conditions or are incomplete in any respect are liable to rejection.
20. Contractors should, in addition the details of their registration etc. particulars of Electrical work carried out by them including the details of organization for whom they have built, their location and cost etc. alongwith the original tender.
21. Contractor(s) should, in addition the details of their registration etc., particulars of building/sanitary works/electrical work carried out by them including the details of organization for whom they have built, their location and cost etc. along with the original tender.
22. Contractors must quote for all the items of the schedules together otherwise their tenders are likely to be treated as incomplete. The building contractor, if he is himself not a registered Sanitary contractor/electrical contractor will have to get sanitary work/electrical work done through licensed plumber/electrician. The entire work will be given to only one contractor.
23. Except writing rates and amounts contractor(s) should not write any condition or make changes. Additions, alterations, and modification, in the printed form of tenders. Contractors should give rebates, if any, and modification, conditions etc in a separate forwarding letter if they so desire. Tenders containing modifications in printed form shall be treated as invalid. Conditional rebates will not be considered for comparison.
24. Any additions, subtractions, alterations, in tender conditions or rates and amounts, submitted by tenderers after submission of tender will not be considered, unless the tenderers are called by the departments to make the same.
25. Tenders will be valid for a period of 90 days from the date of opening, which can be extended, if so agreed to by both the parties.
26. Tenderers must a brief PERT/BAR CHART along with their tender showing how they would complete the work in the prescribed time. After the award of the work, the successful tenderer will submit a detailed CPM+PERT CHART of the entire work within a period of **four months** from the date of signing of the agreement. The detailed chart thus prepared and accepted by the Department shall form part of the agreement between the parties.
27. After award of work, the successful tenderer will have to submit names and qualifications with details of experience of the supervisory staff to be deputed for the work. He should also communicate changes if any, in names so communicated. He Should also give list of the major tools and plants to be deployed for work.
28. This tender document will form part of the agreement



APPENDIX

Defects liability period	12 months from the date of virtual completion as certified by the Architect/Engineer.
Time for completion	Four Months from the date of start as given in work order
Minimum value of work for Interim payment.	4.00 Lakhs or less as per Discretions of Engineer-In-charge, but not more than one running payment per month.
Earnest money to be deposited with the tender	Rs28,100.00 (Rupees Twenty eight thousand one hundred only)

RETENTION MONEY FOR INTERIM PAYMENTS SECUTIRY DEPOSIT (SEE SPECIAL CONDITIONS)

i)	Earnest Money:	Rs28,100.00 (Rupees Twenty eight thousand one hundred only)
ii)	Subsequent retention inclusive of earnest money deposited at the time of submitting the tender	A sum @ 10% of the gross amount of the bill shall be deducted from each running bill of the contractor till the sum along with the sum already deposited as earnest money, will amount to security deposit of 5% of the tendered value of the work. In addition, the contractor shall be required to deposit an amount equal to 5% of the tendered value of the contract as Performance Security within the period prescribed for commencement of work in the letter of award issued to him



Modified terms of refund of security deposit are as under: (These supersede the conditions given also where in the tender documents)

The refund of the security deposit shall be made only after the defect liability period is over and the final bill is paid as per provision of contract, no interim refund of any percentage of security deposit is admissible.

Period of submitting of final bill by the contractor : Two months from the date of virtual completion

CEMENT AND STEEL Arranged by Contractor as per contract provision.



CONDITIONS FOR CONTRACT

Notice Inviting Tenders

Sealed tenders are hereby invited in “**Two Bid system**” **Technical bid and Financial bid** for the work : **Replacement of the LT panel board of 3rd phase lab. Building, TPN - MCB DB’s panel of the 2nd phase lab. Building, replacement of old cables and installation of additional feeder pillar etc. at CSIR CIMAP Lucknow** from ‘A’ class approved electrical contractors of CPWD, State PWDs. Railway or MES, Public undertakings, UPPCL, registered for carrying out Electrical work from those who have carried out similar works for CSIR, Govt and Semi government organizations or Public Sector Undertaking Institutions etc. Tenderers should have successfully completed at least three work amounting to 40% (**Rs 5.62 Lakhs**) or two works of 50% (**Rs. 7.02Lakhs**) or at least one work amounting to 80% (**Rs11.23 Lakhs**) value of the estimated cost or above in single contract during the last five year. Tenders will be issued to only those contractors who show the satisfactory work completion certificates and proof of their registration under works contract tax, etc.

1. Estimated cost is **Rs14.03 Lakhs**. (based on market rate and CPWD DSR – 2013)
2. Time for carrying out the work will be **Four Months**.
3. Complete Contract documents to be complied with by the tenderer whose tender may be accepted can be seen at the office of **Controller of Administration, CIMAP, CENTRAL INSTITUTE OF MEDICINAL AND AROMATIC PLANTS , Post office CIMAP, Lucknow-226015**
4. Tenders should be on the specified form. (Non-transferable) which may be obtained from the Office of **Controller of Administration, CIMAP, CENTRAL INSTITUTE OF MEDICINAL AND AROMATIC PLANTS , Post office CIMAP, Lucknow-226015** during office hours on payment of Rs **500.00** in cash (non-refundable). Sale of tenders shall be stopped two days before the date of opening of tenders.
5. Tenders should be submitted in double sealed covers superscribed with the name of the work date and time of opening written both on the inner and outer envelopes. They will be received up to **2.30 P.M** on **03.11.2014** and **Technical bid** will be opened at **3.30. P.M** on the same day in the office of **COA/AO, Central Institute of Medicinal and Aromatic Plants, Post office – CIMAP, Lucknow – 226015**, Tenders should be dropped in the tender before the closing date and time indicated. In case these are sent by post there should be sent by Regd. Post, speed post addressed to **COA/AO, Central Institute of Medicinal and Aromatic Plants, Post office – CIMAP, Lucknow – 226015**. Tenderers are to ensure that the post the tender well in advance so as to reach before the closing time and date indicated.



6. The Earnest money amounting to **Rs28,100.00 (Rupees Twenty eight thousand one hundred only)** as demand draft or pay order of a schedule bank and drawn in favour of **Director, Central Institute of Medicinal and Aromatic Plants, Post office – CIMAP, Lucknow - 226015** should accompany the tender. Tenders received without earnest money will be invalid.
7. The Employer does not bind himself to accept the lowest or any tender and reserves to himself the right of accepting the whole or any part of the tender and the tenderer shall be bound to perform the same at the rates quoted.
8. Canvassing in connection with the tenders is prohibited and the tenders submitted by contractor who resort to canvassing are liable for rejection.
9. The tenderer shall not be permitted to tender for works in the concerned unit of CSIR in which a relative is posted in the grade between Controller of Administration and Junior Engineer, (both inclusive). He shall also intimate the names of persons who are working with him in any capacity or subsequently employed by him and who are relatives as mentioned above.

NOTE: A person shall be deemed to be a relative of another if, and only if, (a) they are members of Hindu undivided family; or (b) they are husband and wife; or (c) the one is related to the other in the following manner: Father, Mother (including Step mother), Son (including step son), Sons wife, Daughter (including step daughter), Father, Son's son, Son's son's wife, Son's daughter, son's Daughter's husband, Daughter's husband, Daughter's son's wife, Daughter's daughter, Daughter's daughters husband, Brother (including step brother), wife, Sister (including step sister). Sister's husband.
10. Tender submitted shall remain valid for 90 days from the date of opening for the purpose of acceptance and award of work, validity beyond 90 days from the date of opening shall be by mutual consent.
11. The tenderer shall quote rates both in figures and words. He shall also workout the amount for each item of work and write in both figures and words. On check if there are differences between the rates quoted by the tenderer in words and in figures or in the amount worked out by him, the following procedure shall be followed.



- (i) When there is difference between the rates in figures and in words, the rates which correspond to the amounts worked out by the tenderer shall be taken as correct.
 - (ii) When the amount of an item is not worked out by the tenderer or it does not correspond with the rate written either in figures or in words, the rate quoted by the tenderer in words shall be taken as correct.
 - (iii) When the rate quoted by the tenderer in figures and in words tallies but the amount is not worked out correctly the rate quoted by the tenderer shall be taken as correct and not the amount.
12. The tenderer should see drawings and in case of doubt, obtain required particulars, which may in any way influence his tender from the Engineer as no claim whatsoever will be entertained for any alleged ignorance thereof.
 13. Before tendering, the tenderer shall inspect the site to fully acquaint himself about the condition in regard to accessibility of site, nature and extent of ground, working condition of site and locality including stacking of materials, installations of tools and plants (T & P) etc., conditions affecting accommodations and movement of labour etc. required for the satisfactory execution of the work contract. No claim whatsoever on such account shall be entertained by the Employer in any circumstances.
 14. Earnest money will be forfeited if the contractor fails to commence the work as per letter of award.
 16. Except writing rates and amount, the tenderer should not write any conditions or make any changes, additions, alterations and modifications in the printed form of tenders. Tenderers who are desirous to offer rebate the same should be brought out separately in the covering letter and submitted along with the tender.
 17. Some of the provisions of General Conditions of Contract are given below. Interpretation however shall be as given in the General Conditions of Contract.
 - (a) **Defects Liability Period:** Twelve months from the date of completion as certified by the Employer.
 - (b) **Minimum Value Of Work For The Intermediate Certificate:** (4.00 Lakhs or less as per Discretions of Engineer-In-charge, but not more than one running payment per month). Intermediate certificate for a lesser amount can be admitted for payment at the discretion of the Engineer.
 - (c) **Security Deposit:** A sum@1 0% of the gross amount of the bill shall be deducted from each running bill of the contractor till the sum along with the sum already deposited as earnest money, will amount to security deposit of 5% of the tenderer value of work. In addition, the contractor shall be required to deposit an amount equal to 5% of the tendered value of the contract as performance Security within the period prescribed for commencement of work in the letter of award issued to him.



(d) **Compensation:** Contractor shall pay as-compensation and amount equal to one percent or such smaller amount as the Employer (whose decision in writing shall be final) may decide on the cost of whole work as shown in the agreement, for every week that the work remains uncommenced or unfinished or due quantity of work remains incomplete after the proper dates. Compensation to be paid shall not exceed ten percent of the estimated cost of the work as shown in the agreement.

18. Schedule showing approximate quantity of materials to be supplied by the Employer under Clause: 6 of the General Conditions of Contract for works contracted to be executed and to rates at which they are to be charged for.

Particulars of materials	Approx. Qty.	Rates at which the material will be charged to the contractor			Place of Delivery Stores, <u>(NAME OF THE LABORATORY)</u>
		Unit	Rs. (Figures)	Rupees	
1. Cement 2. Steel		CONTRACTOR'S SUPPLY			

NOTE: The Tenderer shall ensure that particulars in the above form are filled in by the engineer before he submits the tender.

19. For all specialist jobs e.g., lights, air conditioning, public address, fire protection, security *I* surveillance and building management systems, technical (covering also general conditions and commercial terms) and financial offers will be given separately in two sealed covers.



II ARTICLES OF AGREEMENT

ARTICLES OF AGREEMENT MADE AT _____ this _____ day of _____ BETWEEN the Council of Scientific & Industrial Research, New Delhi, a society registered under the Societies Registrations Act 1860 (Hereinafter referred to as the Employer, which expression shall include its successor and assignees and authorised officers of the Society) of the one part and _____ trading in the name and style of _____ (herein after referred to as the contractor(s) which expression shall include his/ their respective heirs, executors, administrators and permitted assignees) of the other part.

WHEREAS the Employers is desirous of getting the work ofdone and has caused drawings, schedule of Quantities and Specifications describing the work to be prepared.

AND Whereas the said specifications and the schedule of quantities and other documents have been signed by on behalf of the parties.

Now it is hereby agreed and declared by and between the parties hereto as follows:

1. In consideration of the payments to be made to them as hereinafter provided the Contractor shall upon and subject to the conditions hereinafter contained executed and complete, the work at the rates specified in the attached schedule of quantities and with such materials as are provided for and in accordance in all respect with specifications, designs, drawings and instructions in writing. Time for carrying out the work will be **Ten Months** and the date of commencement be reckoned from the **tenth day** of issue of award letter.
2. The Employer shall pay to the Contractors such sum as shall become payable hereunder at the items and in the manner specified in the said conditions.
3. This agreement contains the following documents in addition to pages of Articles of Agreement.
 - (i) General Conditions of Contract Page No _____ to _____.
 - (ii) Special Conditions Page No _____ to _____.
 - (iii) Additional Conditions Page No _____ to _____.
 - (iv) Indenture for Secured Advance Page No _____ to _____.
 - (v) Original tender document along with the covering letter of the firm dated Page No: 1 to _____.
 - (vi) _____.
 - (vii) _____.
 - (viii) _____.



In witness whereof the parties hereto have set their respective hands the day and year in above written.

Signed by, for and on behalf of Employers _____

In the presence of

(1) _____ (2) _____.

Signed by the said contractor

In the presence of

(1) _____ (2) _____.



GENERAL CONDITIONS OF CONTRACT

1. Interpretation

(a) In construing these conditions, the Specifications, the Schedule of Quantities, Tender, Special Conditions and Agreement, the following words shall have the meaning herein assigned to them except where the subject or context otherwise requires.

(b) This contract shall comprise of the Articles of Agreement, General Conditions of Contract, Special Conditions. Additional Special Conditions, the Schedule of Quantities, Specifications, letter of acceptance of tender and other documents mentioned in the contents sheet attached hereto and including these to which only reference is made herein.

Work or Works: Shall mean all work or works defined in schedule of quantities, specification and such other work or works as the contractor may be entrusted with for carrying out under this contract.

Employer: Shall mean Director-General, CSIR or any officer authorized by Director-General for the purpose.

Engineer: Shall mean the Engineer designated by the Employer to superintend and perform other duties as indicated in the contract.

Contractor: Shall mean the individual or Firm or Company, whether incorporated or not. Undertaking the work and shall include the legal personal representative or such individual or the persons composing such Firm or Company or the successors of such Firm or Company and the permitted assignees of such individual or Firm or Firms or Company.

Site: Shall mean the site of the contract works including any buildings and erections thereon and any other land adjoining thereto (inclusive) as aforesaid allotted by the Employer or the Engineer for the contractor's use.

Compensation: Shall mean all sum payable by way of compensation under any of the conditions shall be considered as reasonable compensation without reference to the actual loss or damage sustained and whether or not any damage sustained, and whether or not any damage shall have been sustained. Words imputing persons include firms and corporations; Words imputing the singular only also include the plural and vice versa where the context so required.

The headings are given to the clauses for convenience and they will not limit the meaning or scope of the clauses in any way.

2. Drawings and Specifications

The Contractor shall execute whole and every part of the work in the most substantial and workmanlike manner both as regards material and otherwise in every respect in accordance with the specifications. The contractor shall also confirm exactly and faithfully to the design, drawings and instructions given in the respect of the work by the Engineer. The contractor shall be furnished free of charge one- copy of such specifications and all such designs, drawings and instructions as are not included in the printed publications.

3. Earnest Money Deposit (EMD)

EMD upto the value of **Rs.10,000/-** may be deposited in cash and when value of EMD exceeds **Rs.10,000/-** then EMD should be deposited in the shape of **DD/PO** upto the value of **RS.25** lacs. If EMD amount is in excess of **RS.25** lacs then the excess amount over **RS.25** lacs can be accepted in the form of Bank Guarantee issued by a scheduled bank.

4. Contractor to Provide Everything Necessary

(a) The contractor shall provide at his own cost all materials (except such materials, if any as may in accordance with the contract be supplied by the Employer) plants, tools, appliance, implements, ladders, scaffolding, temporary works, etc. requisite or proper for the execution of the work whether original, altered or substituted and whether included in the specifications or other documents forming part of the contract or which may be necessary for the purpose of satisfying or complying to the requirements of Engineer, as to any manner as to which under these conditions he is entitled to be satisfied together with carriage therefore to and from the work. The contractor shall also supply without charge the requisite number of persons with means and materials necessary for the purpose of setting out works and counting, weighing and assisting in the measurement or examination at any time and from time to time of the work or materials. Failing his so doing, the same may be provided by the Engineer **at the expense of the contractor** and the expenses may be deducted from any money due to the contractor under the contract and / or from his Security Deposit.



(b) The contractor shall provide himself with requisite quantity and quality of water for carrying out the works at his own, if, however piped water is supplied by the Employer, the contractor shall pay for the water at **one percent of** the total of the work done except on Electrical Work, Air-conditioning work and Furniture work. The contractor shall make own arrangement for water connection and laying of further pipelines from the source of supply of the Employer. It should be clearly understood that the Employer does not guarantee to maintain uninterrupted supply of water and it will be incumbent on the part of the contractor to make alternative arrangement for water at his own cost in the event of any temporary breakdown in the water mains so that the progress of work is not held up for want of water. No claim as damages or refund of water charges will be entertained on account of such breakdowns. However, if the contractor is permitted to make his own arrangement to draw water from a well, hand-pump, or natural river or pond of the Employer, no charges will be made for the water drawn from the same, but the contractor will make good any damage done to the installations and ensure that the quality of water used in the work is conforming to BIS codes and provide for any treatment at his own cost.

(c) The contractor shall be allowed to construct temporary wells in Employer's land for taking water for construction purpose only after he has permission of the Employer in writing. No charges shall be recovered from the contractor on this account but the contractor shall be required to provide necessary safety arrangement to avoid any accident or damage to adjacent buildings, roads and service lines. He shall be responsible for any accident or damage caused due to construction and subsequent maintenance of the wells and shall restore the ground to its original condition after the wells are dismantled on completion of the work.

(d) The Employer on no account shall be responsible for the expenses incurred by the contractor for hired ground or water obtained for elsewhere.

(e) Subject to availability the Employer may **supply power** at only one point from where the Contractor shall make his own arrangement for distribution including provision of electric meters, switches, fuses etc. at his own cost. These shall be in the custody of the Employer. If there is any hinderance caused to other works the contractor shall reroute or remove such temporary lines without any extra cost. Such temporary lines shall be removed after the completion of work. The cost of power consumed by the contractor shall be payable to the employer at rates fixed by the Employer, which would be deducted from the running account bills. However the Employer does not guarantee the supply of power and no compensation for any failure or short supply of power shall be entertained.

“Sufficiency of Tender:

The contractor shall be deemed to have satisfied himself before tendering as to the correctness and sufficiency of the tender the works and the rates and the prices quoted in the schedule of items, which rates and the prices shall, except as otherwise provided, cover all his obligation under the contract and all matters and things necessary for the proper completion and maintenance of the works”.

5. Authorities, Notice & Patents

(a) The contractor shall confirm to any regulations and bye-laws of any corporation and of any electricity supply company and authorities with whose systems the structure is proposed to be connected, and shall before making any variations from the drawing and specifications that may be necessitated for so conforming by giving written notice to the Engineer specifying the **variations proposed** to be made, the reasons for making it and apply for instructions thereon. If the compliance with this clause involves any extra work not included in this contract, he shall specify these items of work and the allowance of extra payment required on their account.

(b) The contractor shall give all notices required by the said regulations or bye-laws to be given to any Authority and pay to such Authority or to any public office all fees that may be chargeable in respect of the works and lodge the receipts with the bill to the Engineer for reimbursement.

6. Rates to include all Taxes

(a) Rates quoted by the contractor shall **include sales tax**, duties, octroi, toll tax, realties and all other taxes in respect of this contract and the Employer shall not entertain any claim whatsoever in this respect. Tendered rates are inclusive of all taxes levies payable under the respective statutes. However pursuant to the Constitution (Forty Sixth Amendment) Act; 1982 if any further tax or levy is imposed by Statutes, after the date of receipt of tenders and the contractor there upon necessarily and properly pays such taxes/ levie the contractor shall be reimbursed the amount as per the rules on producing proof of payment so made provided such payments, if any, is not in the opinion of the Employer (whose decision shall be final and binding) attributable to delay in execution of work within the control of the contractor.



(b) The contractor shall keep necessary books of accounts and other documents for the purpose of this condition as may be necessary and shall allow inspection of the same by a duly authorized representative of the Employer and further shall furnish such other information and documents as the Employer may require.

(c) The contractor shall within a period of thirty days of imposition of any **further tax** or levy pursuant to the Constitution (Forty Sixth Amendment) Act, 1982 give a written notice thereof to the Employer that the same is given pursuant to this condition together with all necessary information relating thereto.

7. Materials

(a) If the specifications of schedule of items provide for the use of any material to be supplied by the Employer's stores or if it is required that the contractor shall use certain stores to be provided by the Employer as shown in the schedule of materials hereto annexed, the contractor shall be bound to procure and shall be supplied such materials and stores as are from time to time required to be used by him for the purpose of the contract only and value of the materials so supplied at the rates specified in the said schedule of materials and of the quantities incorporated in the work may be set off or deducted from any sums then due, or thereafter to become due to the contractor under the contract or otherwise or against or from the Security deposit. All materials so supplied to the contractor by the Employer shall remain the absolute property of the Employer and the contractor shall be the trustee of the materials so supplied procured and the said materials shall not be removed/disposed off from the site of the work on any account and shall be at all times open for inspection by the Engineer or Employer. The contractor shall bear all incidental charges for cartage, storage and safe custody of all materials and against damage due to dampness, rain, sun, fires and theft and be fully responsible for their storage and maintenance. Any such material unused and in perfectly good condition in the opinion of the Employer at the time of the completion of work or termination of the contractor or earlier shall be returned to the Employer at a place directed by the Engineer at contractor's cost and at rates stipulated in the said schedule but in case the Employer decides not to take back the materials the contractor shall have no claim for compensation on account of any such materials supplied to him as aforesaid being unused by him or for any wastage or damage to any such materials.

(b) If for any reason there is delay or non-supply of material as shown in the schedule, the contractor shall procure the same and complete the work in time after due intimation and approval of the Employer. The difference in price (between his procurement price and price shown in the schedule) shall be paid to the contractor. However, in case approval of the Employer is not given, only suitable extension of time would be considered and no other claim of compensation/damages shall be payable by the Employer.

(c) After completion of the work or on determination/ termination of the contract, the theoretical quantity of cement to be used in work shall be calculated on the basis of statement showing quantity of cement to be used in different items of work provided in current Schedule for the purpose printed by CPWD. In case any item is executed for which the standard contents for the consumption of cement are not available in the above mentioned statement or cannot be derived from this statement, the same shall be calculated on the basis of standard formula to be laid down by the Engineer. Over this theoretical quantity of cement shall be allowed a variation upto 3% plus/minus for works estimated cost of which as put to tender is not more than Rs.10 lakhs and upto 2% plus/ minus for works estimated cost of which as put to tender is more than Rs. 10 lakhs. The difference in the quantity actually issued to the contractor and the theoretical quantity including authorised variation if not returned by the contractor, shall be recovered at twice the issue rate, without prejudice to the provision of other conditions regarding return of material governing the contract. In the event of its being discovered that the quantity of cement which is less than the quantity ascertained as herein before provided (allowing variation on minus side as stipulated above) the cost of quantity of cement not so used, shall be recovered from the contractor on the basis of stipulated issue rates and cartage to site.

(d) The provisions of foregoing sub-clause shall apply Mutatis-Mutandis in the case of steel reinforcement structural steel sections (each diameter/ section or category shall be considered separately) except that the theoretical quantity of the steel be taken as the quantity required as per design or as authorised by the Engineer, including lappages, plus 3% wastage due to cutting into pieces. Over this theoretical quantity 2% plus/ minus shall be allowed as variation due to wastage.



(e) The provision of foregoing sub-clause shall apply Mutatis-Mutandis in the case of cables; (other than under-ground cables) wires, conduits/ GI pipes, GI/ MS sheets used in various items of work shall be calculated on the basis of measurements recorded in the measurement books for the purpose of payment and for assessing the Consumption of materials used in the works. Over this quantity a variation of 5% plus shall be allowed for wastage of materials during execution in case of cables (other than under-ground cables), wires, conduits GI pipes, and 10% plus in case of GI/ MS Sheets.

(f) The provisions made above are without prejudice to the right of the Employer to take action against the contractor under the conditions of the contract for not doing the work according to the prescribed specifications.

(g) "In case of easy availability of approved quality of cement and steel in the open market it will be Employer's discretion to make these items as contractor's supply".

8. Testing of Materials

The contractor shall provide assistance, instruments, materials, labour and any other arrangement normally required for testing, checking of materials and workmanship as stipulated in the specifications and by statutory authority at his own cost. The Employer has the right to appoint the testing authorities. The contractor shall pay for the cost of test samples, its packing, transportation including testing fees. Failings his so doing, the same shall be provided by the Engineer at the expense of the contractor and the expenses may be deducted from any money due to the contractor under the contract and/ or from the Security Deposit or proceeds thereof or of a sufficient portion thereof.

9. Contractor's Engineers/ Foreman & Workman

(a) The contractor shall give all necessary personals superintendence during the execution of the (work and as long thereafter as the Engineer may consider necessary until the expiration of the Defects Liability Period. The contractor shall employ competent Site-Engineer/ Foreman as per CPWD norms and as approved by the Engineer Whose qualification must conform to the requirement specified by the Engineer who shall be constantly in attendance of the work while the men are at work. Any directions, explanations, instructions or notices given by the Engineer to such Site-Engineer or Foreman or any other authorized agent shall be held to be given to the contractor.

(b) Contractor's Site Superintendence Staff to be employed by contractor on works: The contractor shall employ the following technical staff during execution of works

(a) For building and road works

(i) One Graduate Engineer, when the tendered cost of work exceeds Rs. 10 lakhs

(ii) One qualified Diploma holder (overseer) with experience not less than 3 years when the tendered cost of work exceeds Rs. 5 lakhs but is less than RS.10 lakhs.

(iii) One qualified Diploma holder when the tendered cost of work is more than RS.2lakhs but less than RS.5lakhs.

(b) For sanitary and water supply works

One qualified diploma holder with experience of not less than 5 years, out of which one year should be in sanitary and water supply works when the tendered cost of work is more than Rs.50,000.



(c) For electrical works

- (i) One qualified Graduate Engineer possessing Degree in Electrical Engineering from recognized university with an experience of not less than 3 years or a Diploma holder in Electrical Engineering with an experience of not less than 7 years when the tendered cost of the work is not less than RS.1.5 lakhs.
 - (ii) One Graduate Electrical Engineer with two years experience or a Diploma holder in Electrical Engineering with experience of not less than 3 years when the tendered cost of the work is more than RS.75,000 but less than Rs. 1.5 lakhs.
 - (iii) One Diploma holder in Electrical Engineering with experience of not less than 3 years when tendered cost of work is more than Rs. 37,000, but less than Rs.75,000.
 - (iv) One licensed Supervisor with experience of not less than 3 years when the tendered cost of work is more than Rs.7,500 and less than Rs.37,000.
- (d) In case the contractor fails to employ the technical staff as aforesaid, he shall be liable to pay reasonable amount not exceeding the amount shown below for each month. of default. These recoveries are subject to modification, from time to time by CSIR based on CPWD.
- (i) In case when a Graduate Engineer is to be employed Rs. 3,000
 - (ii) In case when a qualified Diploma holder is required to be employed Rs. 1,500
 - (iii) In case when a technical Supervisor is required to be employed Rs. 750
- (e) The contractor shall on the request of the Engineer immediately dismiss from the works any person employed thereon who may in the opinion of the Engineer be unsuitable or incompetent or who may in the opinion of the Employer misconduct himself.

10. Access

- (a) The Engineer, and the Employer or its representatives shall at all reasonable time have free access to the works and/or workshops, factories or other places the materials are being prepared or constructed for the contract and also to any place where the materials are lying or from which they are being obtained and the contractor shall give every facility to them for inspection. Except the representatives of statutory authorities and those mentioned above no other person shall be allowed on the works at any time without the permission of the Engineer.
- (b) If any work is to be done at a place other than the site of works, contractor shall obtain written permission of the Engineer.

11. Variation & Price for Variation

- (a) The Engineer with the approval of the Employer shall have powers to make any alterations/ omissions/ additions and/ or substitutions from the originals specifications, drawings, designs and written instructions of such alterations, omissions, additions, substitutions shall not invalidate the contract and any altered, additional or substituted work which the contractor may be directed to do in the manner specified above as part of the work shall be carried out by the contractor on the same conditions in all respects on which he agreed to do the main work. The rates for such altered, additional or substituted work under this clause shall be worked out in accordance with the following provisions in their respective order.
- (b) If the rates for the altered, additional, or substituted work are specified in the contract for the work, the contractor is bound to carry out the altered, additional, or substituted work at the same rates as are specified in the contract for the work.
- (c) If the rates for the altered, additional, or substituted work are specified in the contract for the work, the contractor is bound to carry out the altered, additional, or substituted work at the same rates as are specified in the contract for the work.



(d) If the rates for the altered, additional, or substituted work cannot be determined in the manner specified in sub-clause (b) and (c) above, then the contractor shall, with 10 working days from the date of receipt of the order to carry out the work through notice in writing; inform the Engineer of the rate which it is his intention to charge for such class of work, supported by analysis of the rate claimed which shall be based on actual cost of work plus 10% as contractor's profit and overheads except in case of departmental materials for which contractors profit and over-heads shall be 2.5%. When such notice has been given, the Engineer with the consent of the Employer may agree to such a rate but if the Engineer does not agree to the contractor's rate the Engineer may cancel his order to carry out such class of work and arrange to carry out in such a manner as he may consider advisable.

(e) Under no circumstances, the contractor shall suspend the work on the plea of non-settlement of rates of items falling under the clause.

(f) "Deviation limits"

Building work	30%
Maintenance/emergency works	50%
Foundation works	100%
Services works	30%

12. **Faulty Materials, Workmanship & Defects After Completion**

(a) The Engineer shall have powers to require the removal from the site of all materials and work which in his opinion are not in accordance with specifications and in case of default, the Engineer shall be at liberty to employ other persons to remove the same without being answerable or accountable for any loss or damage that may happen or arise to such materials to be substituted thereof and in case of default the Engineer may cause the same to be supplied and all costs which may attend such removal and/ or substitution are to be borne by the contractor.

(b) If it shall appear to the Engineer or to the Employer based on audit/ technical examination that any work has been executed with unsound, imperfect, or unskillful workmanship or with materials of any inferior description, or that any materials or articles provided by him for the execution of the work are unsound or of a quality inferior to that

contracted for or otherwise not in accordance with the contract, any defects, shrinkage or other faults which may appear within the defects liability period of 12 months from the date of completion arising in the opinion of the Engineer, the contractor shall on demand in writing which shall be made within 12 months of the completion of the work from the Engineer specifying the work, materials, articles defects or other faults complained of notwithstanding that the same may have been passed, certified and paid for, forthwith rectify, or remove and reconstruct the work so specified in whole or in part, as the case may require or as the case may be, remove the materials or articles so specified and provide other proper and suitable materials or articles at his own cost. In case of any such failures, the Engineer may rectify or remove or re-execute the work or remove and replace with others, the material or articles complained of as the case may be at the risk and cost in all respects of the contractor.

(c) In lieu of rectifying the work not done in accordance with the contract, the Employer may, allow such work to remain, and in that case make allowance for the difference in value, together with such further reduction as in his opinion may be reasonable.

(d) Provided always that nothing in this clause shall relieve the contractor from his liability to execute the works in all respects in accordance with the terms and conditions of this contract, or from his liability to make good all defects.

13. **Works to Be Open for Inspection**

(a) All work under or in course of execution or executed in pursuance of the contract shall at all times be open to the inspection and supervision of the Engineer and the contractor shall at all times, during the usual working hours, and at all other times at which reasonable notice of the intentions of the Engineer to visit the works shall have been given to the contractor, either himself be present to receive order and instruction or have a responsible agent duly accredited in writing present for that purpose.



(b) The contractor shall give not less than seven days notice in writing to the Engineer before covering up or otherwise placing beyond the reach of measurement any work in order that the same may be measured and correct dimensions thereof be taken before the same is so covered up or placed beyond the reach of measurement and shall not cover up and place beyond the reach of measurement, any work without the consent in writing of the Engineer and the Engineer shall within the aforesaid period of seven days inspect the work, and if any work shall be covered up or placed beyond the reach of measurement without such notice having been or the Engineer's consent obtained the same shall be uncovered at the contractor's expense or in default thereof. No payment or allowance shall be made for such work or the materials with which the same was executed.

14. Assignment or Sub-Letting

- (a) The contract shall not be assigned or sublet without the written approval of the Employer. And if the contractor shall assign or sub-let his contract or attempt to do so or become insolvent or commence any insolvency proceedings or make any composition with his creditors or attempt to do so or if any bribe, gratuity or gift, loan, perquisite, reward or advantage pecuniary or otherwise, shall either directly or indirectly, be given, promised or offered by the contractor or any of his servants or agents to any person in the employment of the Employer in any way relating to his office or employment, or if any such employee or person shall become in any way directly or indirectly interested in the contract, the Employer shall have the power to adopt any of the courses specified under clause-23 as may be best suited to the interest of the Employer and in the event of any of the courses being adopted the consequences specified in the said clause shall ensue.
- (b) Where the contractor is a partnership firm, the approval in writing of the Employer shall be obtained before any changes in the constitution of the firm. Where the contractor is an individual or a Hindu undivided family business concern such approval as aforesaid shall likewise be obtained. The contractor enters into any partnership agreement hereunder the partnership firm would have the right to carry out the work hereby undertaken by the contractor. If previous approval as aforesaid is not obtained, the contract shall be deemed to have been assigned or sublet in contravention of clause 13 (a) and the same action may be taken and the same consequences shall ensue as provided in the said clause 13 (a).

15. Indemnifying Against Damages to Persons, Property & Statutes

The contractor shall take all precautions to avoid all accidents by exhibiting necessary caution boards day and night, speed limit boards, red flags, red lights and providing barriers. He shall be responsible for all damages and accidents caused due to negligence on his part. No hindrance shall be caused to traffic during the execution of work.

- (a) The contractor shall be responsible for all injury to persons, animals or things, and for all damage, whether such injury or damage arises from carelessness or accident in any way connected therewith. This clause shall be held to include inter alia any damage due to causes as aforesaid to work, building (whether immediately adjacent or otherwise) and to roads, streets, foot paths, bridges or ways as well as all damage caused to the buildings and works forming the subject of this contract by inclemency of weather. The contractor indemnifies the Employer and holds him harmless in respect of all expenses arising from such injury or damage as aforesaid and also in respect of any award of compensation or damage consequent upon such claim including legal costs.
- (b) The contractor shall reinstate all damage of every sort mentioned in this clause, so as to deliver the whole of the contracted works complete and perfect in every respect and so as to make good and otherwise satisfy all claims for damage as aforesaid to the property of third parties.
- (c) The contractor also indemnifies the Employer against all claims which may be made upon the Employer for acts during the currency of this contract by any employee or representative of an employee of the contractor or any sub-contractors, employed by him, for any injury to or loss of life, of such employees, or for compensation payable under any law for the time being in force to any workmen or to the representative of any deceased or incapacitated workmen.



- (d) The contractor also indemnifies the Employer against all claims which may be made upon the Employer for acts during the currency of this contract by the Central/ State Government or local Municipal authorities for the noncompliance of any laws, regulations, rules pertaining to wages act, safety act in force and any amendments thereof in respect of all labour and apprentices directly or indirectly employed in the work under this contract.
- (e) The Employer shall be at liberty and is hereby empowered to deduct the amount of any damages, compensation costs, charges and/ or expenses arising or accruing from or in respect of any such claim and/ or damages as aforesaid from any sum or sums due or to become due to the contractor or security deposit.
- (f) The contractor shall indemnify the employer against any action, claim or proceedings relating to infringement or sue of any patent or design or any alleged patent or design rights and shall pay any royalties which may be payable in respect of any article or part thereof included in the contract. In the event of any claims made under or action brought against the Employer in respect of any such matters as aforesaid the contractor shall be immediately notified thereof and the contractor shall be at liberty, at his own expense, to settle any dispute or to conduct any litigation that may arise therefrom. Provided that the contractor shall not be liable to indemnify the Employer if the infringement of the patent or design or any alleged patent or design right is the direct result of an order passed by the said Employer or his authorized representative.

16. Lien in Respect of Claim in Other Contracts

- (a) Any sum of money due and payable to the contractor including the security deposit under the contract may be withheld or retained by way of lien by the Employer or Government or any other contracting person or persons against any claim of the Employer or Government or such other persons in respect of payment of a sum of money arising out of or under any other contract made by the contractor with the Employer or Government or with such other persons.
- (b) It is agreed term of the contract that the sum of money so withheld or retained under this clause by the Employer will be kept withheld or retained as such by the Employer or till his claim arising out of in the same contract or any other contract is either mutually settled or determined by the Arbitrator if the contract is governed by arbitration clause or by the competent court as the case may be, and that the contractor shall have no claim for interest or damages whatsoever on this account or any other ground in respect of any sum of money withheld or retained under this clause and duly notified as such to the contractor.

17. Withholding & Lien in Respect of Sums Claimed

- (a) Whenever any claim or claims for payment of a sum of money arises out of or under the contract against the contractor, the Employer shall be entitled to withhold and also have a lien to retain such sum or sums in whole or in part from the security deposit if any deposited by the contractor and for the purpose aforesaid, the Employer shall be entitled to withhold the security deposit, if any, furnished as the case may be and also have a lien over the same pending finalisation or adjudication of any such claim. In the event of the security deposit being insufficient to cover the claimed amount or amounts or if no security deposit has been taken from the contractor, the Employer shall be entitled to withhold and have a lien to retain to the extent of such claimed amount or amounts referred to above, from any sum or sums found payable or which at any time thereafter may become payable to the contract under the same or any other contract, with the, Employer or any contracting person pending finalisation or adjuication of any such claim.

It is an agreed terms of the contract that the sum of money so withheld or retained under the lien referred above, by the Employer will be kept withheld or retained as such by the Employer till the claim arising out of or under the contract is determined by the Arbitrator (if the contract is governed by the arbitration clause) or by the competent court as the case may be and that the contractor will have no claim for interest or damages whatsoever on any account in respect of such withholding or retention under the lien referred to above and duly notified as such to the contractor. For the purpose of this clause, where the contractor is a partnership firm or a limited company the Employer shall be entitled to withhold and also have a lien to retain towards such claimed amount or amounts in whole or In part from any sum payable to any Partner/ Limited company as the case may be, whether in his individual capacity or otherwise.



- (b) The Employer shall have the right to cause an audit and technical examination of the works and the final bills of the contractor including all supporting vouchers, abstract etc., to be made after payment of the final bill and if as a result of such audit and technical examination any sum is found to have been over paid in respect of any work done by the contractor under the contract or any work claimed by him to have been done by him under the contract and found not to have been executed, the contractor shall be liable to refund the amount of over payment and it shall be lawful for the Employer to recover the same from him in the manner prescribed in sub-clause (a) of this clause or in any other manner legally permissible; and if it is found that the contractor was paid less than what was due to him under the contract in respect of any work executed by him under it, the amount of such under-payment shall be duly paid by the Employer to the contractor.

Provided that the Employer shall not be entitled to recover any sum over-paid, nor the contractor shall be entitled to payment of any sum paid short where such payment has been agreed upon between the Employer on the one hand, and the contractor on the other hand under any term of contract permitting payment for work after assessment by the Employer.

18. In-Case of Death of Contractor

Without prejudice to any of the rights of remedies under this contract, if the contractor dies, the Employer shall have the option of terminating the contract without compensation to the contractor.

19. Sub -Contractors

The Employer reserves the right to use the premises and any portion of the site for the execution of any work not included in the contract. The contractor is to afford all reasonable facilities to all sub-contractor, specialists, merchants, tradesmen and others who may at any time be appointed by the Employer for executing any work or supplying any goods relating to the construction, servicing, equipping or furnishing of the work under this contract.

20. Compliance to Labour Laws & Apprentice Act

The contractor shall comply with an the provisions of the Minimum Wages Act, 1948, Contract Labour (Regulation and Abolition) Act, 1970, and rules and orders framed there under and other labour laws affecting contract labour and Apprentice Act, 1961 and the rules and orders framed there under that may be in force or brought into force from time to time.

Contractor shall obtain a valid license under Contract Labour (R&A) Act 1970 and Contract Labour (R&A) Central Rules 1971 before commencing work and which should be valid till the completion.

21. Compensation for Delay

- (a) The time for carrying out the work as entered in the tender shall be strictly observed by the contractor and shall be deemed to be essence for the contract on the part of the contractor. The work shall throughout the stipulated period of the contract be proceeded with all due diligence and the contractor shall pay as compensation an amount equal to ONE PER CENTOR such smaller amount as the employer (whose decision in writing shall be final) may decide on the amount of the whole work as shown in the agreement, for every week that the work remains uncommenced or unfinished after the purpose.

- (b) And further to ensure good progress during the execution of the work, the contractor shall be bound in alt cases. in which the time allowed for any work exceeds one month (say for special jobs) to complete one-eighth of the whole of the work before one-fourth of the whole time allowed under the contract has elapsed: three-fourths of the work before three-fourths of such time has elapsed. However for special jobs if a time schedule has been submitted by the contractor and the same has been accepted by the Employer, the contractor shall comply with the said time schedule. In the event of the contractor failing to comply with this condition he shall be liable to pay as compensation an amount equal to one per cent or such smaller amount as the Employer (whose decision in writing shall be final) may decides on the said cost of the work for every week that the due quantity of work remains incomplete. Provided that the entire compensation to be paid under the provisions of this clause shall not exceed ten percent on the estimated cost of the work as shown in the tender.



22. Damage to Works in Consequence of Hostilities or War-Like Operation

- (a) The work (whether fully constructed or not) and all materials, machines, tools and plants, scaffolding, temporary buildings and others things connected therewith shall be at the risks of the contractor until the work has been delivered to the Employer and a certificate from him to that effect obtained. In the event of the works or any materials properly brought to the site for incorporation in the work being damaged or destroyed in consequence of hostilities or war-like operations, the contractor shall, when ordered in writing by the Employer, remove any debris from the site, collect and properly stored or remove from store all serviceable materials salvaged from the damaged work and shall be paid at the contract rates in accordance with the provision of this agreement for the work of clearing the site of debris, stacking, removal of serviceable materials and for the reconstruction of all works ordered by the Employer such payment being addition to compensation upto the value of the work originally executed before being damaged or destroyed and not paid for. In case of works damaged or destroyed but not already measured and paid for the damage/ destruction suffered and for restoring the material at the rates based on the analysis of rates tendered for in accordance with the provision of this agreement. The certificate of the Employers regarding the quality and quantity of materials and the purpose for which they were collected shall be final and binding on the contractor.
- (b) Provided always that no compensation shall be payable for any loss in consequence of hostilities or war-like operations (i) unless the contractor had taken all such precautions against Air Raid as are deemed necessary by the A. R. P. Officers or the Employer, (ii) for any materials etc., not on the site of the work or for any tools and plant, machinery, scaffolding, temporary buildings and other things not intended for the work.
- (c) In the event on the contractor having to carry out reconstruction as aforesaid, he shall be allowed such extension of time for its completion as is considered reasonable by the Employer.

23. Extension of Time

- (a) If the contractor shall desire an extension of time for the completion of the work on the grounds of his having been unavoidably hindered in its execution or any other ground he shall apply in writing to the Employer within thirty days of the date of hindrance on account of which he desires extension-as aforesaid, and the Employer shall, if in his opinion (which shall be final) reasonable grounds shown therefore, authorise such extension of time if any, which may, in his opinion, be necessary or proper
 - (b) In the event, the value of work exceeds the value of the Bill of Quantities owing to variations, the contractor shall be entitled to ask for extension of time in proportion to the increased value of work.

24. Suspension of Work by Contractor

- (a) The Employer may without prejudice to his right against the contractor in respect of any delay or inferior workmanship or otherwise or to any claims for damages in respect of any breaches of the contract and without prejudice to any rights or remedies under any of the provisions of this contract or otherwise and whether the date for completion has elapsed by notice absolutely determine the contract in any of the following cases:
 - (i) If the contractor having been given by the Engineer to rectify, reconstruct or replace any defective work or that the work is being performed in any inefficient' or otherwise improper or unworkman-like manner shall omit to comply with the requirements of such notice for a period of seven days thereafter or if the contractor shall delay or suspend the execution of the work so that in the judgment of the Employer (which shall be final and bindings) he will be unable to ensure completion of the work by the date for completion or he has already failed to complete the work by that date.
 - (ii) If the contractor being a company shall pass a resolution or the court shall make an order that the company shall be wound up or if a receiver or a manager on behalf of a creditors shall be appointed or if circumstances shall arise which entitle the court of creditor to appoint a receiver or a manager or which entitle the court to make a winding up of order.



- (iii) If the contractor commits breach of any of the terms and conditions of this contract.
- (v) If the contractor commits any acts mentioned in clause-23th thereof.
- (b) When the contractor has made himself liable for action under any of the cases aforesaid, the Employer shall have the following powers:
 - (i) To determine or rescind the contract as aforesaid (of which termination or rescission notice in writing to the contractor under the hand of the Employer shall be conclusive evidence). Upon such determination or recession the security deposit of the contractor shall be liable to be forfeited and shall be absolutely at the disposal of the Employer.
 - (ii) The Engineer may employ labour paid by the Employer and to supply materials to carry out the work or any part of the work debiting the contractor with the cost of the labour and the price of the materials (of the amount of which cost and price certified by tile Engineer shall be final and conclusive against the contractor) and crediting him with the value of the work done in all respects in the same manner and at the same rates as if it had been carried out by the contractor under the terms of his contract. The certificate of the Engineer as to the value of the work done shall be final and conclusive against the contractor, provided always that action under the sub-clause shall only be taken after giving notice in writing to the contractor. Provided also that if the expenses incurred by the Employer are less than amount payable to the contractor at his agreement rates, the difference should not be paid to the contractor.
 - (iii) After giving notice to the contractor to measure up the work of the contractor and to take such part thereof as shall be unexecuted out of his hands and to give it to another contractor to complete in which case any expenses which may be incurred in excess of the sum which would have been paid to the original contractor if the whole work had been executed by him (of the amount of which exceed the certificate in writing of the Engineer shall be final and conclusive) shall be borne and paid by the original contractor and may be deducted from any money due to him by the Employer under this contract or any other account whatsoever or from his security deposit.
 - (iv) In the event anyone or more of the above courses being adopted by the Employer the contractor shall have no claim to compensation for any loss sustained by him by reason of his having purchased or procured any materials or entered into any engagement or made any advances on account or with view to the execution of the work or the performance of the contract. And in case action is taken under any of the provisions aforesaid, the contractor shall not be entitled to recover or be paid any sum for any work thereof or actually performed under this contract unless and until the Engineer has shall certified in writing the performance of such work and the value payable in respect thereof and he shall only be entitled to be paid the value so certified.

25. Secured Advance

The contractor on signing an indenture in the form specified by the Employer during the progress of the execution of the work may be paid if agreed by the Employer upto 75 percent of the estimated value which shall take into account the market value and contractor tendered rates for the finished item of any material which in the opinion of the Engineer is likely to be incorporated in the work within next three months, are non-perishable and are in accordance with the contract and which have been brought on the site in connection therewith and are adequately stored and protected against damage by weather or other causes, which have not at the time of advance been incorporated in the works. When materials on account of which an advance has been made under this clause are incorporated in the worth the amount of such advance shall be deducted from the next payment made under any of the clause of clauses of this contract.



26. Certificates & Payments

- (a) No payments shall be made for a work estimated to cost Rupees ten thousand or less till the whole of the work shall have been completed and certificate of completion given. But in the case of a work estimated to cost more than Rupees ten thousand, the contractor shall, on submitting the bill entitled to receive a monthly payment proportionate to the part of the work executed and to the satisfaction of the Engineer, whose certificate of the "sum so payable shall be final and conclusive against the contractor, provided the amount of work done is as per the value of intermediate certificate or for a lesser amount at the discretion of the Engineer as mentioned in the NIT. All such intermediate payments shall be regarded as payments by way of advance against the/ final payment only and not as payments for work actually done and completed and shall not preclude the requiring of bad, unsound, imperfect or unskilled work to be removed and taken away and reconstructed, or recreated or be considered as an admission of the due performance of the contract, or any part thereof in any respect or the accruing of any claim nor shall it conclude, determine, or affect in any way the powers of the Employer under these conditions or any of them as to the final settlement and adjustment of the accounts or in any other way affect the contract. The final bill shall be submitted by the contractor within two months of the date fixed for the completion of work or of the date of the certificate of completion furnished by the Employer and payments shall be made within three months if the value of the completed works is upto Rupees Two lakhs and in six months if the same exceeds Rupees Two lakhs of the submission of such bill. If there shall be any dispute about any item or items of the work then the undisputed item or items only shall be paid within the said period of three months or six months as the case may be.
- (b) Whenever there is likely to be delay in recording detailed measurements for making a running payment, advance payment without detailed measurements for work done worked out at 75 percent of the tendered rates for assessed quantities may be made in running account bills by the Employer on the basis of a certificate from the Engineer. The advance payments so allowed shall be adjusted in the subsequent running bills by taking detailed measurements thereof. Final payments shall be made only on the basis of detailed measurements.
- (c) A bill shall be submitted by the contractor each month on or before the date fixed by the Engineer on printed forms obtainable from the Engineer's office. The Engineer shall take or cause to be taken the requisite measurements for the purpose of having the same verified and the claim, as far as admissible, adjusted as far as possible, before the expiry of ten days from the presentation of the bills. If the contractor does not submit the bill within the time fixed as aforesaid the Engineer may take action within seven days of the date fixed as aforesaid, an authorised representative to measure up the said work in the presence of the contractor whose signature to the measurement will be sufficient warrant and the Engineer may prepare the bill from such measurements.
- (d) Before taking any measurement of any work the Engineer or his authorised representative deputed by him shall give reasonable notice to the contractors. If the contractor fails to attend after such notice or fails to sign or to record the difference within a week from the date of measurement in the manner required by the Engineer then in any such event the measurements taken by the Engineer or by the authorised representative deputed by him as the case may be, shall be final binding on the contractor and the contractor shall have no right to dispute the same.
- (e) The charges in the bills shall always be entered at the rates specified in the agreement or in the case of any extra work ordered in pursuance of these conditions and not mentioned or provided for in the agreement at the determined as per-clause-10. However in case of partially executed items of work, the Employer at his discretion allows proportionate rates for such items of work as determined by the Engineer whose certificate of the sum so payable shall be final and conclusive against the contractor.



27. Security Deposit

- (a) A sum @ 10% of the gross amount of the bill shall be deducted from each running bill of the contractor till the sum along with the sum already deposited as earnest money, will amount to security deposit of the 5% tender value of the work. In addition, the contractor shall be required to deposit an amount equal to 5% of the tendered value of the contract as Performance Security within the period prescribed for commencement of work in the letter of award issued to him.
- (b) In case a fixed deposit receipt of any scheduled bank is furnished by the contractor to the Employer as part of the Security deposit and the bank goes into liquidation or for any reason is unable to make payment against the said fixed deposit receipt, the loss caused thereby shall fall on the contractor and the contractor shall forthwith on demand furnish additional security to the Employer to make good the deficit of such sum from the running bill as mentioned above. Such deductions will be held by the Employer by way of security deposit, provided always that the Employer for this purpose shall be entitled to recover the said percentage of the amount from each running bill till the balance of the amount of security deposits is realised. All compensation or the other sums of money payable by the contractor under the terms of this contract may be deducted from the security deposit or from the interest arising therefrom or from any sums which may be due to or may become due to the contractor by the Employer on any account whatsoever and in the event of his security deposit being reduced for any reason whatsoever and in the event of his security deposit being reduced for any such deductions aforesaid, the contractor shall within ten days make good in cash or further fixed deposit receipt pledged in favour of the Employer. The security deposit shall be collected from the running bills of the contractor at the rates mentioned above and the earnest money if deposited at the time of tenders will be treated as part of the security deposit.
- (c) The contractor if he so desires may furnish fixed deposit receipt in advance towards the security deposit. Such fixed deposit receipt shall be of a minimum value of Rs.25,000/- each. (The last such fixed deposit receipt could be of a lower value on the basis of the amount) In case any recovery is effected from running account bills, such recovered amount shall not be replaced with fixed deposit receipt. It is in the contractor's interest to keep a watch about the adequacy of the fixed deposit receipt submitted.
- (d) No partial refund of security deposit shall be made during the defect liability period. In case the final bill is not settled within stipulated period for reasons beyond control and the Employer is satisfied that the security deposit is not required for adjustment of Employer dues or whatsoever dues either in this or any other contract then this security deposit either in full or in part could be refunded at the sole discretion of the Employer. However, release of security deposit would be only after written clearance of Labour Officer regarding no dues or claims is received.
- (f) In case of termination of contract, this security deposit shall be forfeited and amount necessary to make up this amount shall be recovered from money due to the contractor under this contract, or any Contract with the Employer.

1. Completion Certificate

Within ten days of the completion of the work, the contractor shall give notice of such completion to the Employer and within ten days of the receipt of such notice the Engineer shall inspect the work. If there is no defect in the work the Employer shall furnish the contractor with certificate of completion otherwise a certificate of completion indicating defects shall be issued but the work shall not be considered to be completed until the contractor shall have removed from the premises on which the work shall be executed all the scaffolding, surplus material, rubbish, and all the huts and sanitary arrangements required for his work, people on the site in connection with execution of the works as shall have been erected or constructed by the contractor and cleaned of the dirt, splashes, droppings of finishing items from all wood work, doors, windows, walls, floors or other parts of any building, in or about which the work is to be executed or of which he may have had possession for the purpose of the execution thereof. If the contractor shall fail to comply with requirements of this clause on or before the fixed date for the completion of the work, the Employer may at the risk and cost of the contractor take action as he may think fit and the contractor shall have no claim except for any sum actually realised by the sale thereof.



2. Escalation

If the prices of materials not being supplied by the Employer and/ or wages of labour required for execution of the works increase, the contractor shall be compensated for such increase as per provisions detailed below and the amount of the contractor shall accordingly be varied, subject to the condition that compensation for escalation in prices shall be available only for the work done during the stipulated period of the contract including such period for which the contract is validly extended under the provisions of Clauses-22 of General Conditions of Contract without levy of compensation under Clause-20 of General Conditions of Contract and also subject to the condition that no such compensation shall be payable for a work and also which the stipulated period of completion is six months or less. Such compensation for escalation in the prices of materials and labour when due shall be worked out based on the following provisions.

- (i) The base date for working out such escalation shall be the last date on which the tenders were stipulated to be received.
- (ii) The cost of work on which escalation will be payable shall be reckoned as 85% of the cost of the work as per the bills, running or final, and from this amount the value or material supplied by the Employer and proposed to be recovered in the particular bill shall be deducted before the amount of compensation for escalation is worked out. In case of materials bought to site for which secured advance is included in the bill full value of such materials as assessed by the Engineer in charge (and not the reduced amount for which secured advance has been paid) shall be included in the cost of work done for operation of this clause. Similarly when such materials are incorporated in the work, the secured advance is deducted from the bill full assessed value of the materials originally considered for operation of this clause shall be deducted from the cost of work shown in the bill running or final. Further the cost of work shall not include any work for which payment is made for any item at prevailing market rates.
- (iii) The compensation for escalation for materials & labour shall be worked out as per the formula given below:

VM	=	$W \times A / 100 \times (MI - MI_0) / MI_0$
VM	=	Variation in material cost i.e. increase or decrease in the amount in rupees to be paid or recovered
W	=	Cost of work done worked out as indicated in sub para (ii) above.
A	=	Component of materials expressed as percent of the total value of work and is predetermined as 75
MI	=	Index numbers of Wholesale Prices in India for all commodities published by the Reserve Bank of India for the period under reckoning
MI ₀	=	Index numbers of Wholesale prices in India for all commodities published by the Reserve Bank of India and valid on the stipulated date of receipt of tenders
VL	=	$W \times B / 100 \times (LI - LI_0) / LI_0$
VL	=	Variation in labour cost, that is, increase or decrease in the amount in rupees to be paid or recovered
W	=	Value of work done, worked out as indicated in sub para (ii) above.
B	=	Component of labour expressed as percent of the total value of work and is predetermined as 25
L1	=	All India consumer price index numbers for workers published by the Reserve Bank of India for the period under reckoning as for the period under consideration
L1 ₀	=	All India consumer price index numbers for industrial workers published by the Reserve Bank of India and valid on the stipulated date of receipt of tenders.

- (b) The following principle shall be followed while working out indices mentioned in sub para (iii) above.
 - (i) The compensation for escalation shall be worked out at yearly intervals and shall be with respect to the cost of work done during the six calendar months of the said work. The first such payment shall be made at the end of the six months after the month (excluding) in which the tenders was accepted and thereafter at six monthly intervals. At the time of completion of work, the last period for payment might become less than six months, depending on the actual date of completion



ii) The index (MI or LI) relevant to any six months for which such compensation is paid shall be the arithmetical average of the indices relevant to the six calendar months. If the period upto date of completion after the six months covered by the last such installment of payment, is less than six months the index MI or LI shall be the average of indices for the months falling within that period.

(iii) The base index (MI or LI) shall be the relating to the months in which the tender was stipulated to be received.

- a. In the event the price of materials and/ or wages of labour required for execution' of the work decreases there shall be downward adjustment of the cost of work so that the price of materials and/or wages of labour shall be deductible from the cost of work under this contract and in this regard formula herein before stated under this clause shall mutatis mutandis apply, provided that no such adjustment for the decrease in the prices of materials and/ or wages of labour aforementioned would be made in case of contracts in which the stipulated period of completion of the work is six months or less.
- b. Employer shall have the discretion to permit the IIEEMA (Indian Electrical & Electronics Manufacturers' Association) Clause for escalation in case of specialised works e.g lifts and electrical and mechanical installations etc. where the price variation is not similar to building works.

30. Arbitration

- (a) Except where otherwise provided in the contract, all questions and dispute relating to the interpretation of the specification, designs, drawings and instructions, herein before mentioned, and as to the quality or workmanship or materials used in the work or as to any other question, claim, right, matter or thing whatsoever in any way arising out of or relating to the contract, designs, specifications, estimates, instructions, orders on these conditions or otherwise concerning the works, or the execution or failure to execute the same, whether arising during the progress of the work or after the completion or

abandonment thereof, shall be referred to the sole arbitration of the person appointed by the Director General, Council of Scientific and Industrial Research. The arbitrator shall be appointed within 30 days from the receipt of a request by any party. The arbitrator to whom the matter is originally referred, being unwilling or unable to act for any reason, the Director General shall appoint another person to act as arbitrator in accordance with the terms of the contract. Such person shall be entitled to proceed with the reference from the stage at which it was left by his predecessor. The arbitrator shall give speaking award. The Award of the Arbitrator shall be final and binding on the parties. The cost of the Arbitrator shall be borne equally by both the parties.

- (b) It is also a term of the contract that the party invoking arbitration shall specify the dispute or disputes to be referred to arbitration under this clause together with the amount or amounts claimed in respect of each such dispute.
- (c) It is also a term of the contract that if the contractor does not make any demand for arbitration in respect of any claim in writing within 90 days of receiving the intimation from the Employer that the bill is ready for payment, the claim of the contractor will be deemed to have been waived and absolutely barred and the Employer shall be discharged and released of all liabilities under the contract in respect of these claims.
- (d) Subject as aforesaid the provisions of the Arbitration and conciliation Act, 1996, or any statutory modification or re-enactment thereof and the rules made there under and for the time being in force shall apply to the arbitration reference under this clause.

31. Dismantled Material:

The contractor shall treat all material obtained during dismantling of a structure, services sub systems/ installations, excavation of the site for a work etc., as employer's property and such material shall be disposed of to the best advantage of the Employer according to the instructions issued in writing by the Engineer.



32. Performance Guarantee

Performance Guarantee may be taken from the contractor before the award of work, by the officer authorized to award the contract, if and where considered necessary, to ensure that a part or whole of the contract is completed by the contractor. In case of non-performance this guarantee could be encashed.

SPECIAL CONDITIONS – I

1. These special condition are meant to amplify the general specifications and general conditions of contract.
2. Work shall be done as per CPWD specification.

In case of any discrepancy the order of precedence in interpretation shall be as under.

1. Schedule of quantities
 - (ii) Drawings
 2. Additional conditions
 - (iv) General conditions of contract
 3. Special condition
 - (vi) Additional Technical Specifications
 4. CPWD latest Civil and Electrical Specification
 5. IS Codes
 - (ix) International Codes
 - (x) Best Engineering Practice.
3. **Steel**
- (i) Steel to be issued as stated elsewhere in the contract shall be for reinforcement bars for RCC work. For all other items of steel work the contractor shall procure the same.
 - (ii) Reinforcement bars for RCC work will be issued in available coils and straight lengths. No claim for straightening the bars whatsoever shall be entertained.
 - (iii) Issue of steel of diameters above 10 mm dia will be regulated on sectional weight basis, weight being calculated with the help of the standard sectional weights as given in the CPWD latest specifications for conversion of length to weight. However, for bars upto and including 10 mm dia the following procedure shall be adopted. The average sectional weight for each diameter shall be arrived at from samples from each lot of steel received at site. The actual weight of steel issued shall be modified to take into account the variations between the actual and the standard coefficient and the contractor's account will be debited by the cost of this modified quantity only.
 - (iv) For theoretical consumption of steel, reinforcement bars will be balanced diameter wise for the purpose of penal recovery as envisaged in the contract.
4. **Cement**
- Cement to be issued as stated elsewhere in the contract shall be only for site work. For factory made products such as Pre-cast tiles, Hollow concrete blocks, RCC pipes etc. cement shall not be issued.
5. Unless otherwise provided in the schedule of quantities the rates tendered by the contractor shall apply for all heights, lifts, leads and depths of the work and nothing extra shall be payable on this account.
 6. The surplus excavated earth which is beyond the requirement of the Employer's work may be allowed by the Employer to be disposed off by the contractor on his own or sell the surplus excavated earth to private parties at his discretion but nothing extra will be paid for the carriage or disposal of surplus earth if the same is not required for any other work of the Employer



V. ADDITIONAL CONDITIONS

1. The structural and architectural drawings, shall at all time be properly correlated before executing any work. However, in case of any discrepancy in the item given in the schedule of quantities appended with the tender and drawings relating to the relevant item the former shall prevail unless and otherwise given in writing by the Engineer.
2. No payment shall be made to the contractor for any damage caused by rain snowfall, floods or any other natural cause whatsoever during the execution of work. The damage to work will be made good by the contractor at his own cost and no claim on this account shall be entertained.
3. All materials used shall be as per specifications and IS marked wherever applicable. IS marking referred relates to latest BIS code as published by Bureau of Indian Standards upto 30 days before the date of opening the tender.
4. The contractor shall give a performance test of the entire installation(s) as per standard specifications and/ or as directed by the Engineer and will also submit. Test certificates as are required by Municipal. Electrical authority or any other authority. Nothing extra shall be payable for the same other than the fees paid to such authorities which shall be reimbursed on production of receipts.

INDENTURE FOR SECURED ADVANCE

This indenture made the _____ day of _____ 20____ between _____ (hereinafter called the contractor which expression shall where the context so admits or implies be deemed to include his heirs, executors, administrators and permitted assignees) of the one part and Council of Scientific & Industrial Research, New Delhi, a Society registered under the Societies Registration Act 1860 (hereinafter called the Employer which expression shall include its successors and assignees and authorised officer of the Society) of the other part.

WHEREAS by an agreement dated _____ (hereinafter called the said agreement) the contractor has agreed AND WHEREAS the contractor has applied to the Employer that he may be allowed advances on the security of materials absolutely belonging to him and brought by him to the site of the works the subject of the said agreement for use in the construction of such of the works as he has undertaken to execute at rates fixed for the finished work (inclusive of the cost of materials and labour and other charges) AND WHEREAS the Employer has agreed to advance to the contractor the sum of Rs. _____ (Rupees _____) on the security of materials the quantities and other particulars of which are detailed in accounts of secured advances attached to the running account Bill for the said works signed by the contractor on _____ and the Employer has reserved to himself the options of making any further advance or advances on the security of other materials brought by the contractor to the site of the said works. Now THIS INDENTURE WITNESSES that in pursuance of the said agreement and in consideration of the sum of Rs. _____ on or before the execution of these presents paid to the contractor by the Employer (the receipt whereof the contractor both hereby acknowledge) and of such further advances (if any) as may be made to him as aforesaid the contractor both hereby convince and agree with the Employer and declare as follows:

1. That the said sum of Rs. _____ advanced by the Employer to the contractor as aforesaid and all or any further sum or sums advanced as aforesaid shall be employed by the contractor in or towards expediting the execution of the said works and for no other purpose whatsoever.
2. That the materials detailed in the said account of secured advance which have been offered to and accepted by the Employer as security are absolutely the contractor's own property and free from encumbrance of any kind and the contractor will not make any application for or receive a further advance on the security of materials which are not absolutely his own property and free from encumbrances of any kind and the contractor indemnifies the Employer against all claims to any materials in respect of which an advance has been made to him as aforesaid.



3. That the materials detailed in the said account of secured advances and all other materials on the security of which any further advance or advances may hereafter be made as aforesaid (hereinafter called the said materials) shall be used by the contractor solely in the execution of the said works in accordance with the directions of the Engineer and in the term of the said agreement.
4. That the contractor shall make at his own cost all necessary and adequate arrangements for the proper watch, safe custody and protections against all risks of the said materials and that until used in construction as aforesaid the said materials shall remain at the site of the said works in the contractor's custody and on his own responsibility and shall at all times be open to inspection by the Employer or any officer authorised by him. In the event of the said materials or any part thereof being stolen, destroyed or damaged or becoming deteriorated in a greater degree than is due to reasonable use and wear thereof the contractor will forthwith replace the same with other materials of like quality or repair and make good the same as required by the Engineer.
5. That the said materials shall not on any account be removed from the site of the said works except with the written permission of the Employer or any officer authorised by him on that behalf.
6. That the advances shall be repayable in full when or before the contractor receives payments from the Employer of the price payable to him for the said works under the terms and provisions of the said agreement. However if any intermediate payments are made to the contractor on account of work done then on the occasion of each such payment the Employer will be at liberty to make a recovery from the contractor's bill for such payment by deducting therefrom the value of the said materials then actually used in the construction and in respect of which recovery has not been made previously the value for this purpose being determined in respect of each description of materials at the rates at which the amount of the advances made these presents were calculated.
7. That if the contractor shall at any time make any default in the performance or observance in any respect of any of the terms or provisions of the said agreement or of these presents the total amount of the advance or advances that may still be owing to the Employer shall immediately on the happening of such default be repayable by the contractor to the Employer together with interest thereon at twelve percent per annum from the date or respective dates of such advance or advances to the date of repayment and with all costs, charges, damages and expenses incurred by the Employer in or for the recovery thereof or the enforcement of this security or otherwise by reason of the default of the contractor and the contractor hereby covenants and agrees with the Employer to repay and pay the same respectively to him accordingly.
8. That the contractor hereby charges all the said materials with the repayment to the Employer of the said sum of Rs. _____ and any further sum or sums advanced as aforesaid and all costs, charges, damages and expenses payable under these presents PROVIDED ALWAYS AND it is hereby agreed and declared that notwithstanding anything in, the said agreement and without prejudice to the powers contained therein if and whenever the convenient for payment and repayment herein before contained shall become enforceable and the money owing shall not be paid in accordance therewith the Employer may at any time thereafter adopt all or any of the following courses as he may deem best:-
 - (a) Seize and utilize the said materials or any part thereof in the completion of the said works on behalf of the contractor in accordance with the provisions in that behalf contained in the said agreement debiting the contractor with the actual cost of effecting such completion and amount due in respect of advances under these presents and crediting the contractor with the value of work done as if he had carried out in accordance with the said agreement and at the rates thereby provided. If the balance is against the contractor he is to pay same to the Employer on demand.
 - (b) Removed and sell by public action the seized material or any part thereof and out of the money arising from the sale retain all the sums aforesaid repayable or payable to the Employer under these presents and pay over the surplus (if any) to the contractor.
 - (c) Deduct all or any part of the money owing out of the security deposit or any sum due to the contractor under the said agreement.



9. That except in the event of such default on the part of the contractor as aforesaid interest on the said advance shall not be payable.

In witness whereof the said _____ and _____ by the order and under the direction of the Employer have hereunto set their respective hands the day and year first above written.

Signed sealed and delivered

By the said contractor: _____

In the presence of

Signature : _____

Name: _____

Address: _____

Signed by _____

By the order and direction

Of the Employer: _____

In the presence of

Signature : _____

Name: _____

Address: _____



PERFORMANCE GUARANTEE

To

Council of Scientific and Industrial Research

In consideration of Council of Scientific and Industrial Research (hereinafter) called "The Council" having awarded to MIs _____ a Company registered under the Companies Act 1956 (hereinafter) called the Contractor, a contract for (hereinafter) called the said contract under the terms and conditions of an Agreement dated-made between the Council and the 'Contractor hereinafter called the said agreement and Council agreed to accept the Council and the Contractor as herein provided for Rs.. _____ (Rupees _____ only) from a Scheduled Bank towards due performance of the contract by the Contractor as per the terms and conditions of the contract on the condition that the Bank on demand from the Council and without demur pay to the Council the aforesaid amount.

2. We, _____ Bank Ltd., (hereinafter referred to as the 'bank' do hereby undertake to pay to the Council and amount not exceeding Rs. _____ against any loss or damage caused to or suffered or would be caused to or suffered by the Council by reasons of any breach or breaches of any of the terms. of condition of the said agreement by the said contractor.

3. We, _____ Bank Ltd., do hereby undertake to pay the amounts due and payable under this Guarantee without any demur, merely on a demand from the Council by stating the amount claimed is due by way of loss or damage caused to or would be caused to or suffered by the Council for reasons of any breach by the said contractor(s) of any of the terms conditions contained in the said Agreement or by reason of the Contractor(s) failure to perform the said Agreement. Any such demand made on the Bank shall be conclusive as regards the amount due and payable by the Bank under this guarantee. However, our liability under this guarantee shall be restricted to an amount not exceeding Rs. _____.

4. This guarantee shall come into force immediately and continue in force and remain valid till six months after the completion of all works under the said contract which according to the terms of the said contract, should be six months from the probable date of completion viz., the _____ day of _____. If, however, the period of the completion of the works under the said contract is for any reason extended and upon such extension if the Contractor fails, before the terms of this guarantee expires, to furnish a fresh or renewed guarantee for the extended period, the Bank shall pay to Council the said sum of Rs. _____.

5. This guarantee shall not be affected by any change in the constitution of the Bank or of the Contractor.

6. Notwithstanding anything hereinafter contained, the liability of the Bank under this guarantee is restricted to Rs. _____ (Rupees _____ only) and the guarantee shall remain in force till _____ day of 20__ unless claim or demand under this guarantee is presented to the Bank within six months from that date all the rights of Council u'lder this guarantee shall be forfeited and the Bank shall be released and discharged from all obligations hereunder.

(NAME OF THE LABORATORY), FULL ADDRESS



SPECIAL CONDITIONS – II

These special conditions are meant to amplify the general specifications and general conditions of contract.

2. If any discrepancy is noticed between these conditions and specifications, general conditions of contract, drawing, etc., the order of precedence would be mentioned in Contract Document.
3. **Inspection of Site:** The Contractors must visit site before giving tender and must get acquainted with the working conditions. They should include in their rates all preliminary work such as jungle clearance construction of temporary approach roads, cleaning rubbish, pumping out water where necessary to make the area fit for further work etc., to start work and also complete it .

The contractor will be deemed to have included in their tender rates allowance for all such preliminary works.

Water Charges for Building Work Including Services:

Please refer 3 (b) of Contract Document for works.

4. Rates:

Please refer Clause (5) of Contract Document.

5. Increase In Rate on Account Of Increase In Basic Price:

Please refer Clause (5) and (28) of Contract Document.

6. Rates for doors, windows, glazing, louvers should also include cost of fixing them in RCC columns and walls.

Rates shall also include shutters being fixed side hung, bottom hung, or centrally pivoted.

7. Work in Patches and Different Shapes, Cement Slurry Under Flooring etc.,

Even if not specifically mentioned in the schedule of quantities, including preamble of Schedule of quantities, the contractor shall be deemed to have allowed necessary materials, labour, tools and plants etc., required for satisfactory completions of the items of work as indicated in drawings and description given in building specification which shall mean CPWD Specification for works at Delhi Vol, I and II, 1977, unless the item specifies labour only or otherwise. Rate quoted also apply for work in patches strip, small or large areas, and for different shapes. The rates for flooring shall include the cost of cement slurry at bases where required as per specification.

8. Quantities:

All the quantities given in the schedule of Quantities are provisional. The contractors shall be deemed to have given Balanced Rates for each item, irrespective of the quantity to any extent the contractor shall be paid at accepted contract rates only. Council reserves the right to increase or decrease to any extent.

9. Measurements

Under each trade head, various items are given such as RCC Slab, beams, chajjas etc., In case of dispute between the contractor and the employer or any ambiguity as to under which items a particular work is to be measured, the decision of Architect/Engineer shall be final and binding on both the parties to the Contract.

10. Mode of Measurements Not Specified:

If for any items, mode of measurements is not specified the decision of the Architect/Engineer about the mode of measurement shall be final and binding both the parties to the control.



11. Schedule of Rates and Specifications:

"CPWD" Specifications are to be generally followed. However, the contractor shall include in his rates all such items of works which might have been specified as payable extra in CPWD schedule of rates but not specifically included in the tender schedule but are required to be executed to complete the work in accordance with the drawings additional specifications etc., The Employer is not bound to follow the practice and mode of measurements followed by other departments.

12. Work on Holidays:

Contractor shall not carry out work on any Government holidays except with the permission of the Civil Engineer-In-charge. The contract period will be inclusive of such holidays.

13. Labour Wages:

In labour wages either due to market conditions or by notification or legislation nor any claim on that account will be entertained.

14. Cement Consumption:

Please refer Clause (6) of Contract Document.

15. Other Contractors:

The contractor shall afford every facility to other contractors working in the same building or compound. In case of deal in completion of his work due to other contractor's work the contractor shall only have a right to ask for extension of time but no other claims on this or any other account shall be entertained by the Employer.

16. Extension of Time:

Contractor hereby agrees that extension of time required for by the contractor, and granted by the employer shall be treated as an extension of time without any claim of contractor for compensation or damages for any reasons whatsoever including those for which the extension is granted.

17. Drawings, Designs, etc:

Department will make all efforts to give all drawings, designs, decisions etc. time to time and the contractors shall make request, for the same. No claim whatsoever shall however be entertained for compensation of delay in supply of drawings, designs, decisions, running payment etc. from the department. Drawings shown at the time of issue of tenders and forming part of the contract shall indicate scope of work and drawings issued subsequently during the execution of work shall be deemed to be the drawings elaborating the basic scheme. If any detailed drawings show an item for execution, the contract with his claim in any, for final decision. Decision of the Engineer/ Architect, as to whether it is an extra item or not or whether it is covered by contract items and if not, what extra rate should be paid shall be final and binding on both the parties to the contract i.e. contractor and employer.

18. Running Bills:

Minimum value of work for interim certificate shall be contract amount divided by original completion period in months. At the discretion of Civil Engineer a running payment may be allowed for a lesser amount but not more than one running payment will be made in a month. All interim payments will be certified for payment by the Civil Engineer-in-charge of the work and only the final bill will be sent by him to the Engineer I Architect mentioned in the Agreement for certification. Secured Advance payment will not be treated as running bill if paid separately.



19. Security Deposit:

A sum@10% of the gross amount of the bill shall be deducted from each running bill of the contractor till the sum along with the sum already deposited as earnest money, will amount to security deposit of 5% of the tendered value of work in addition, the contractor shall be required to deposit an amount equal to 5% of the tendered value of the contract as performance Security within the period prescribed for commencement of work of ward issued to him. In case of termination of contract, this Security Deposit shall be forfeited and amount necessary to make up this amount shall be recovered from money due to the contractor under this contract, or any other contract with COUNCIL OF SCIENTIFIC & INDUSTRIAL, RESEARCH.

20. Works Supervisor:

Contractor shall keep a qualified and experienced Engineer for supervision of building work to ensure best quality work.

21. Essentiality Certificates/ Permits/ recommendation Letter for Material Available at Controlled Rates:

These would be given by the department, if required by the contractor. It will,

however, be the responsibility of the contractor to obtain material against the certificates or otherwise, and no claim on this account will be entertained by the department. Contractor shall use materials thus procured exclusively in this work and for misuse if any, he shall be solely responsible.

22. Appendix, Notice inviting Tender, Abstract of cost and additional special conditions and Electrical, shall form part of special conditions.

Preparation of Running and Final Bills:

The Civil Engineer/Superintending/Junior Engineer shall take measurements in presence of contractors representative and record them in Measurement Book from time to time and shall prepare abstract for running and final bill including recovery statements. The bill abstract shall be prepared on either standard CPWD form or on contractors letter head, on basis of Civil Engineer's abstract in triplicate. The contractor should sign the bill and Measurement Book with remark "Measurement and bill accepted". However in the final bill, the contractor shall have to certify, the bill accepted in full and final settlement of all claims and demands against this work".

In case, a large amount is blocked in the final bill, pending technical/ audit check, advance up to the extent of 75% of net final amount may be paid to the contractor. With the approval of the Architect/ Engineer at his discretion even after the completion date is over.



CENTRAL INSTITUTE OF MEDICINAL AND AROMATIC PLANTS
(Council of Scientific and Industrial Research)
Post Office-CIMAP, Lucknow-226015

ABSTRACT OF COST

PART – II PRICE BID

Name of work : **Replacement of the LT panel board of 3rd phase lab. Building, TPN - MCB DB's panel of the 2nd phase lab. Building, replacement of old cables and installation of additional feeder pillar etc. at CSIR CIMAP Lucknow**

Schedule of Quantities

Page no. 39	:	Rs.
Page no. 40		Rs.
Page no. 41		Rs.
Page no. 42		Rs.
Page no. 43		Rs.
Page no. 44		Rs.

Total **Rs** (Rupees
only)

ALL MATERIALS SHALL BE OF QUALITY AS SPECIFIED AND APPROVED BY THE ENGINEER/ARCHITECT

1. The contractor should inspect site, examine specifications, schedules of quantities and tender their rates. The rates given in the schedule of quantities will be deemed to include all the necessary materials, T&P, labour required for satisfactory completion of work as shown in the specifications, schedule of quantities.
2. The additional work in the same campus can be awarded during the currency of contract at the same rates, terms and conditions of the contract.
3. All materials, fixture and fittings, required for this work, which are available with ISI certificate mark will be of that quality, even if not specified in the item.

Scope of work : **Replacement of the LT panel board of 3rd phase lab. Building, TPN - MCB DB's panel of the 2nd phase lab. Building, replacement of old cables and installation of additional feeder pillar etc. at CSIR CIMAP Lucknow**

WITNESS

SIGNATURE OF TENDERER

State

Branch

Name of Work : Replacement of the LT Panel board of 3rd phase Lab building and TPN - MCB DB'S Panels of the 2nd phase L.AB. building, Replacement of old cables, installation of additional feeder pillar etc. at CSIR - CIMAP, Lucknow.

Engineering

SCHEDULE OF WORK

ITEM No	SUB-HEADS AND ITEM OF WORK	QUANTITY	UNIT	RATE (Rs)	RATE (In Words)	AMOUNT(Rs)
1	Supply of PVC insulated, PVC Sheathed / XLPE, 1.1 grade aluminium conductor, armored cable ISI / ISO mark					
1.1	16 sq mm X 4 core cable	40.00	Metre			
1.2	50 sq mm X 3.5 core cable	50.00	Metre			
1.3	95 sq mm X 3.5 Core cable	150.00	Metre			
1.4	120 sq mm X 3.5 core cable	300.00	Metre			
1.5	185 sq mm X 3.5 core cable	130.00	Metre			
1.6	400 sq mm X 3.5 core cable	30.00	Metre			

ITEM No	SUB-HEADS AND ITEM OF WORK	QUANTITY	UNIT	RATE (Rs)	RATE (In Words)	AMOUNT(Rs)
2	<p>Supply and Installation of LT panel board, wall/ floor mounted type dust and vermin proof made out of 2mm thick CRCA sheet with powder coated paint over the anti rust treatment of the surface and comprising of heavy duty LT make switch gears Busbar etc. including dismantling and shifting of old panel board as per details given below.</p> <p>(A)Incomer (a)3 pole MCCB -250A (01 no.) Breaking Capacity 35KA</p> <p>(b)Bus-Bar 300amp.TPN Aluminium conductor bus-bar of suitable length insulated with heat shrinkable sleeves and supported on CMC/DMC Support (01 set)</p> <p>(c)Metering 3Ph Multifunction Meter model A Class 1,5A with Relay Make L&T(cat.no.WDM303FDW/A0)or equivalent (01 no.)</p> <p>(d) Indicating light RYB with LED bulb (01 set)</p> <p>(e)Control protection MCB's make HPL/Havells/Indo/L&T (cat. no. BB10060C) (03 nos.)</p> <p>(f)CT's Coil 250/5A Rishab/Nippan or Equivalent (03 nos.) g)outgoing (a)3 pole MCCB -100A (03 nos.) Breaking Capacity 16KA</p>					
2.1	As per drawing enclosed	1.00	Each			

ITEM No	SUB-HEADS AND ITEM OF WORK	QUANTITY	UNIT	RATE (Rs)	RATE (In Words)	AMOUNT(Rs)
3	<p>Supply and Installation of LT panel board, wall/ floor mounted type dust and vermin proof made out of 2mm thick CRCA sheet with powder coated paint over the anti rust treatment of the surface and comprising of heavy duty LT make switch gears Busbar etc. including dismantling and shifting of old panel board as per details given below</p> <p>(A) Incomer</p> <p>(a) 3 pole MCCB -250A (01 no.) Breaking Capacity 35KA</p> <p>(b) 3 pole MCCB -400A (01 no.) Breaking Capacity 35KA</p> <p>(b) Bus-Bar</p> <p>400amp.TPN Aluminium conductor bus-bar of suitable length insulated with heat shrinkable sleeves and supported on CMC/DMC Support (02 set)</p> <p>c) Metering</p> <p>3Ph Multifunction Meter model A Class 1,5A with Relay make L&T(cat.no.WDM303FDWA0)or equivalent (02 nos.)</p> <p>(d) Indicating light RYB with LED bulb (02 set)</p> <p>(e) Control protection MCB's (06 nos.) Make HPL/Havells/Indo/L&T (cat. no. BB10060C)</p> <p>(f) CT's Coil 250/5A Rishab/Nippan or Equivalent (03 nos.)</p> <p>(g) CT's Coil 400/5A Rishab/Nippan or Equivalent (03 nos.) g) outgoing</p> <p>(a) 3 pole MCCB -100A (04 nos.) Breaking Capacity 16KA</p> <p>(h) 4 pole MCB 'C' Series-63A (08 nos.) Make L&T(cat.no.BB40630C) or equivalent</p>					
3.1	As per drawing enclosed	1.00	Each			

ITEM No	SUB-HEADS AND ITEM OF WORK	QUANTITY	UNIT	RATE (Rs)	RATE (In Words)	AMOUNT(Rs)
4	<p>Supply and Installation of LT panel board, wall/ floor mounted type dust and vermin proof made out of 2mm thick CRCA sheet with powder coated paint over the anti rust treatment of the surface and comprising of heavy duty LT make switch gears Busbar etc. including dismantling and shifting of old panel board as per details given below</p> <p>(A)Incomer</p> <p>(a) 3 pole MCCB -250A (01 no.) Breaking Capacity 35KA (b)3 pole MCCB -400A (01 no.) Breaking Capacity 35KA</p> <p>(b)Bus-Bar 400amp.TPN Aluminum conductor bus-bar of suitable length insulated with heat shrinkable sleeves and supported on CMC/DMC Support (02 set)</p> <p>c)Metering 3Ph Multifunction Meter model A Class 1,5A with Relay make L&T(cat.no.WDM303FDWA0)or equivalent (02 nos.)</p> <p>(d) Indicating light RYB with LED bulb (02 set)</p> <p>(e)Control protection MCB's (06 nos.) Make HPL/Havells/Indo/L&T (cat. no. BB10060C)</p> <p>(f)CT's Coil 250/5A Rishab/Nippan or Equivalent (03 nos.)</p> <p>(g)CT's Coil 400/5A Rishab/Nippan or Equivalent (03 nos.) g)outgoing (a)3 pole MCCB -100A (04 nos.) Breaking Capacity 16KA</p> <p>(h) 4 pole MCB 'C' Series-63A (12 nos.) Make L&T(cat.no.BB40630C) or equivalent</p>					
4.1	As per drawing enclosed	1.00	Each			

ITEM No	SUB-HEADS AND ITEM OF WORK	QUANTITY	UNIT	RATE (Rs)	RATE (In Words)	AMOUNT(Rs)
5	Supply and installation of outdoor type LT feeder pillar made out of 1.66mm thick CRCA sheet with powder coated color Siemens grey with double TPN Busbar rating of 300A and 400A Aluminium Busbar insulated with heat shrinkable sleeves mounted on DMC Support. Gland plate also provided size of panel will be approx.- 1000x1700x450mm. Include as per detail given below: 04 nos. outgoing with fuse set (a) Fuse base -400A + fuse -03 set (b) Fuse base -250A + fuse -03 set (c) Fuse base -160A + fuse -24 set					
5.1	As per drawing enclosed	1.00	Each			
6	Supply of outdoor type LT Feeder pillar made out of 1.66mm thick CRCA sheet with powder coated color Siemens grey shade with TPN Busbar rating of 400A Aluminium Busbar insulated with heat shrinkable sleeves mounted on DMC Support. Gland plate also provided size of panel will be approx.- 900x750x400mm.					
6.1	As per drawing enclosed	1.00	Metre			
7	Supply and installation of 800A 4 pole on load type HPL make or equivalent type change over switch in panel made out of 1.66mm thick CRCA sheet with powder coated color Siemens grey shade wall mounted type with TPN Busbar rating of 800A Aluminium Busbar insulated with heat shrinkable sleeves mounted on DMC support gland plate also provided size of panel will be approx.- 1000x700x500mm.					
7.1	As per drawing enclosed	1.00	Metre			
8	Laying of one number PVC insulated and PVC sheathed / XLPE power cable of 1.1 KV grade of following size direct in ground including excavation, sand cushioning, protective covering and refilling the trench etc as required.					
8.1	Upto 35 sq. mm	40.00	Metre			
8.2	Above 35 sq. mm and upto 95 sq. mm	170.00	Metre			
8.3	Above 95 sq. mm and upto 185 sq. mm	290.00	Metre			

ITEM No	SUB-HEADS AND ITEM OF WORK	QUANTITY	UNIT	RATE (Rs)	RATE (In Words)	AMOUNT(Rs)
9	Laying of one number additional PVC insulated and PVC sheathed / XLPE power cable of 1.1 KV grade of following size direct in ground in the same trench in one tier horizontal formation including excavation, sand cushioning, protective covering and refilling the trench etc as required.					
9.1	Above 95 sq. mm and upto 185 sq. mm	120.00	Metre			
10	Laying of one number PVC insulated and PVC sheathed / XLPE power cable of 1.1 KV grade of following size in the existing RCC/ HUME/ METAL pipe as required.					
10.1	Above 95 sq. mm and upto 185 sq. mm	12.00	Metre			
11	Laying and fixing of one number PVC insulated and PVC sheathed / XLPE power cable of 1.1 KV grade of following size on wall surface as required.					
11.1	Above 35 sq. mm and upto 95 sq. mm (clamped with 25x3mm MS flat clamp)	30.00	Metre			
11.2	Above 95 sq. mm and upto 185 sq. mm (clamped with 25/40x3mm MS flat clamp)	8.00	Metre			
11.3	Above 185 sq. mm and upto 400 sq. mm (clamped with 40x3mm MS flat clamp)	30.00	Metre			
12	Supplying and making end termination with brass compression gland and aluminium lugs for following size of PVC insulated and PVC sheathed / XLPE aluminium conductor cable of 1.1 KV grade as required.					
12.1	3½ X 50 sq. mm (35mm)	1.00	Each			
12.2	3½ X 95 sq. mm (45mm)	1.00	Each			
12.3	3½ X 120 sq. mm (45mm)	2.00	Each			
12.4	3½ X 185 sq. mm (57mm)	1.00	Each			
12.5	3½ X 400 sq. mm (82mm)	2.00	Each			
12.6	4 X 16 sq. mm (28mm)	1.00	Each			
	Total					



CENTRAL INSTITUTE OF MEDICINAL & AROMATIC PLANTS

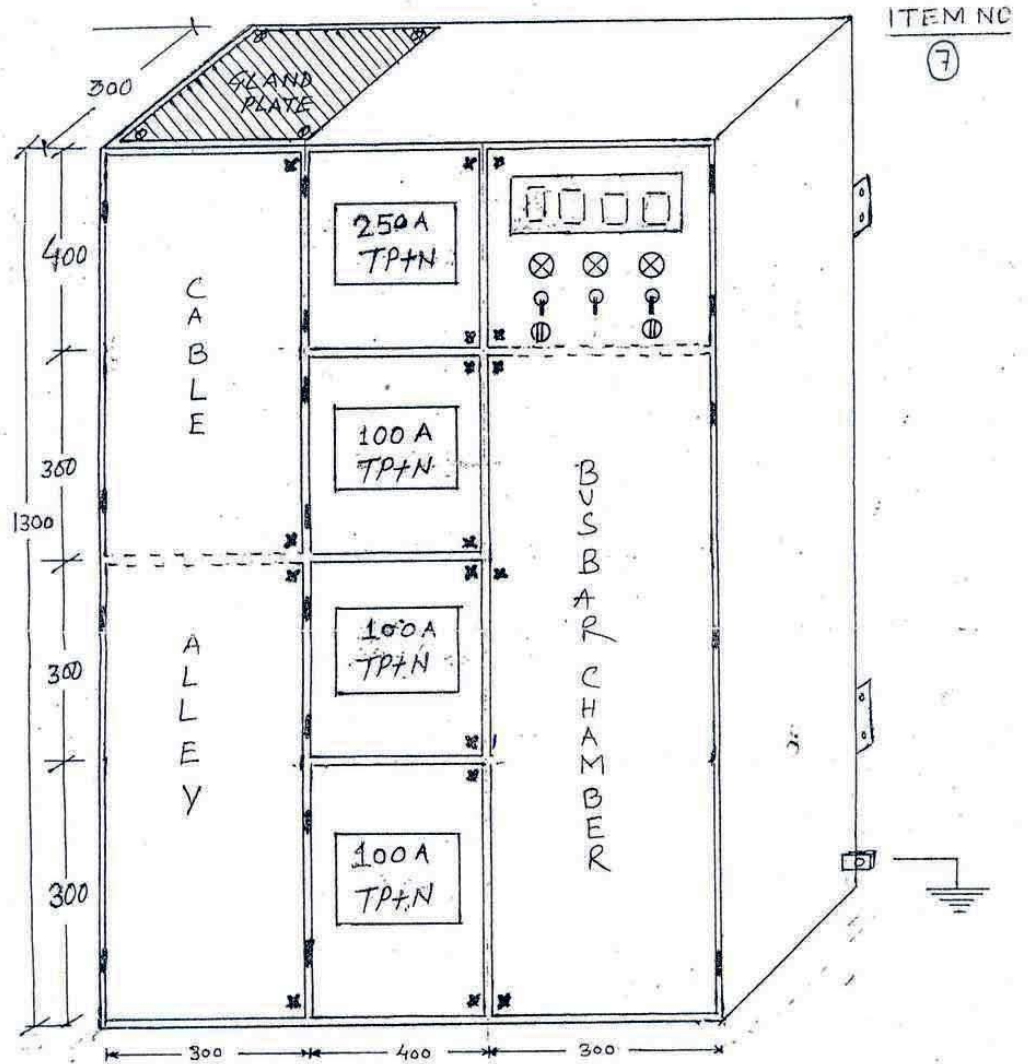

DRAWN BY
LT PANEL BOARD WALL MOUNTED FOR 2nd PHASE SWITCH ROOM

A.K. Shukla
A.K. SHUKLA
T.A. (Elect.)



ITEM NO. - (7)

SINGLE LINE DIAGRAM

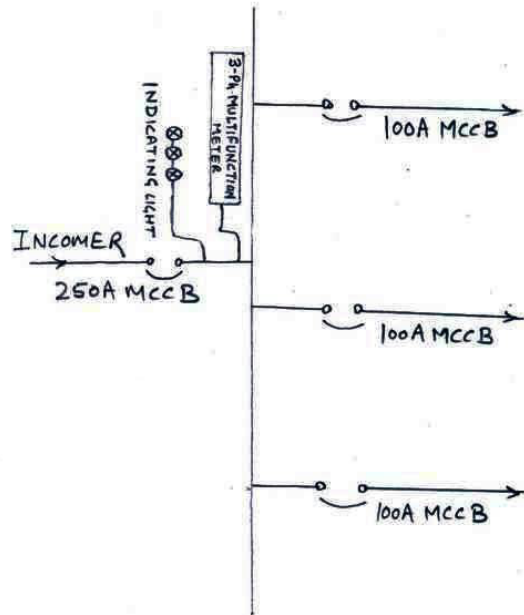

DRAWN BY :-

A. K. Shukla
A. K. SHUKLA
T. A. (ELECT.)

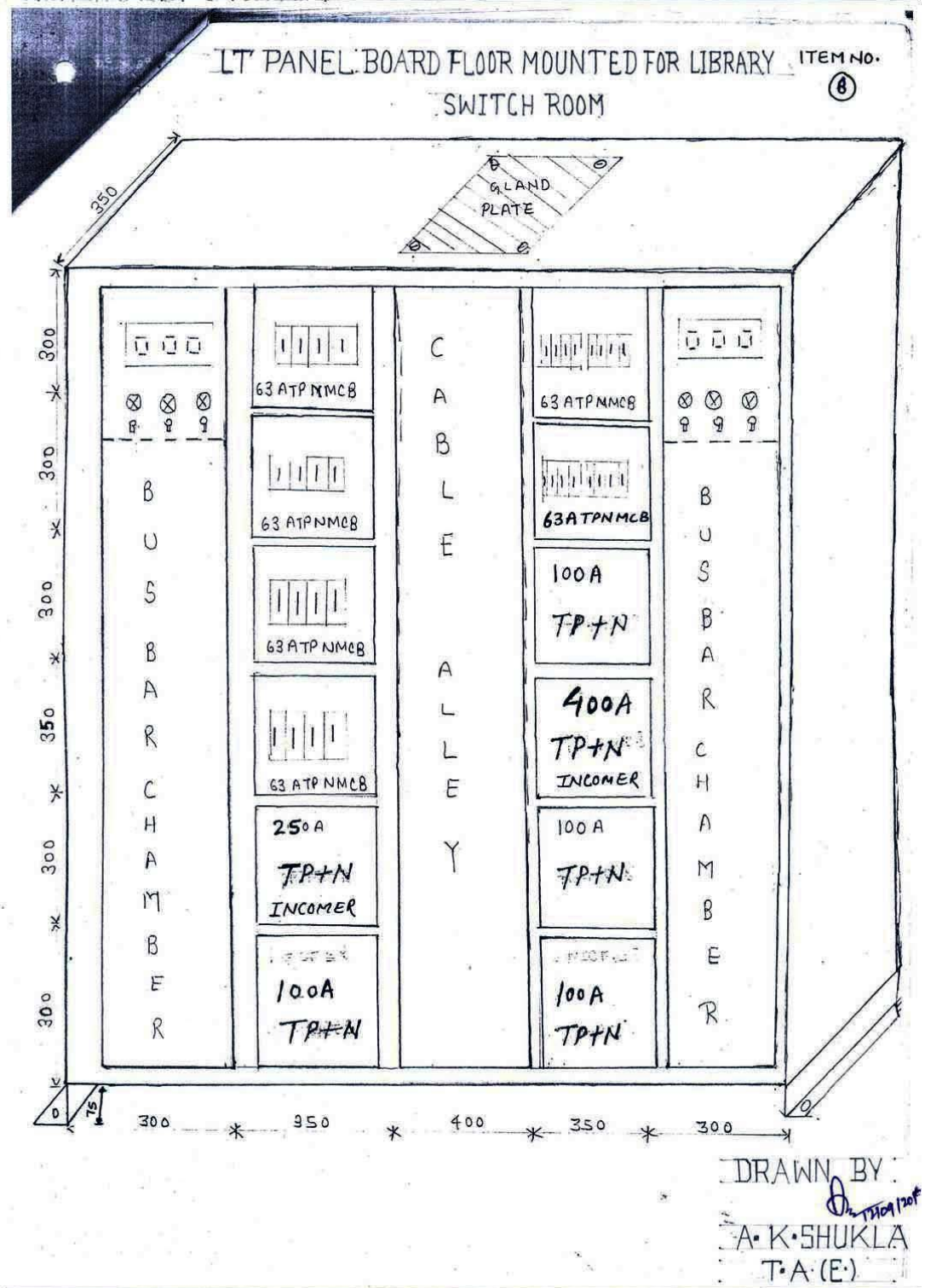



ITEM NO.-④

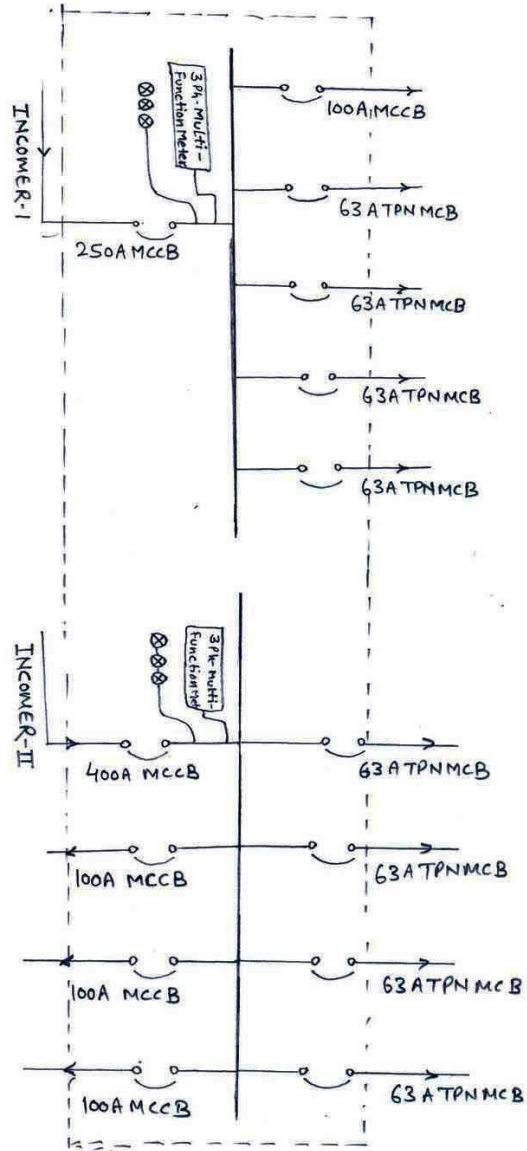

SINGLE LINE DIAGRAM

DRAWN BY

A.K.SHUKLA

T.A.(Elect)

Handwritten signature



LT PANEL BOARD FLOOR MOUNTED FOR 3rd

ITEM No.

9

PHASE SWITCH ROOM

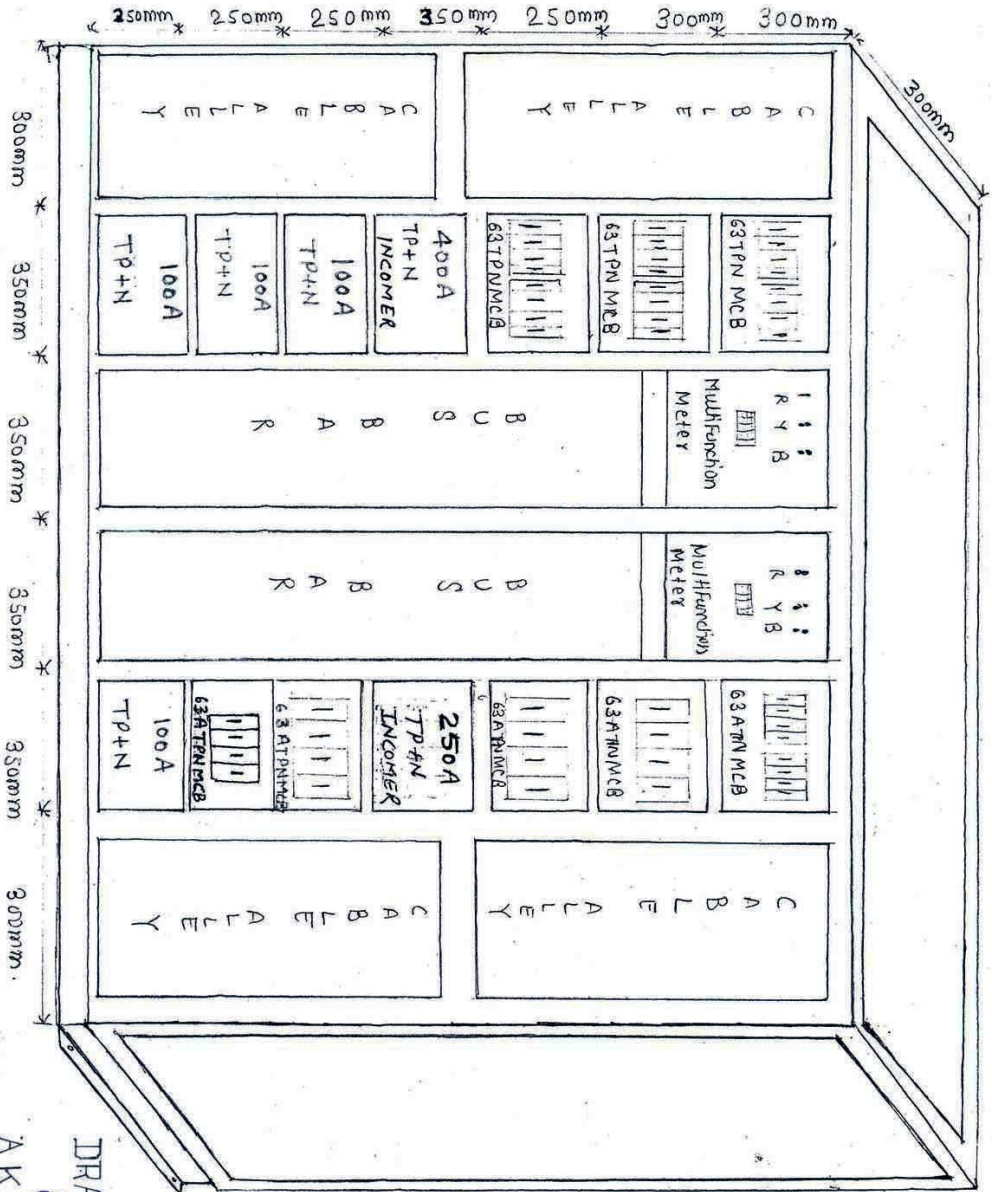

DRAWN BY
A. K. SHUKLA
T.A. (ELECT)



ITEM NO.-9

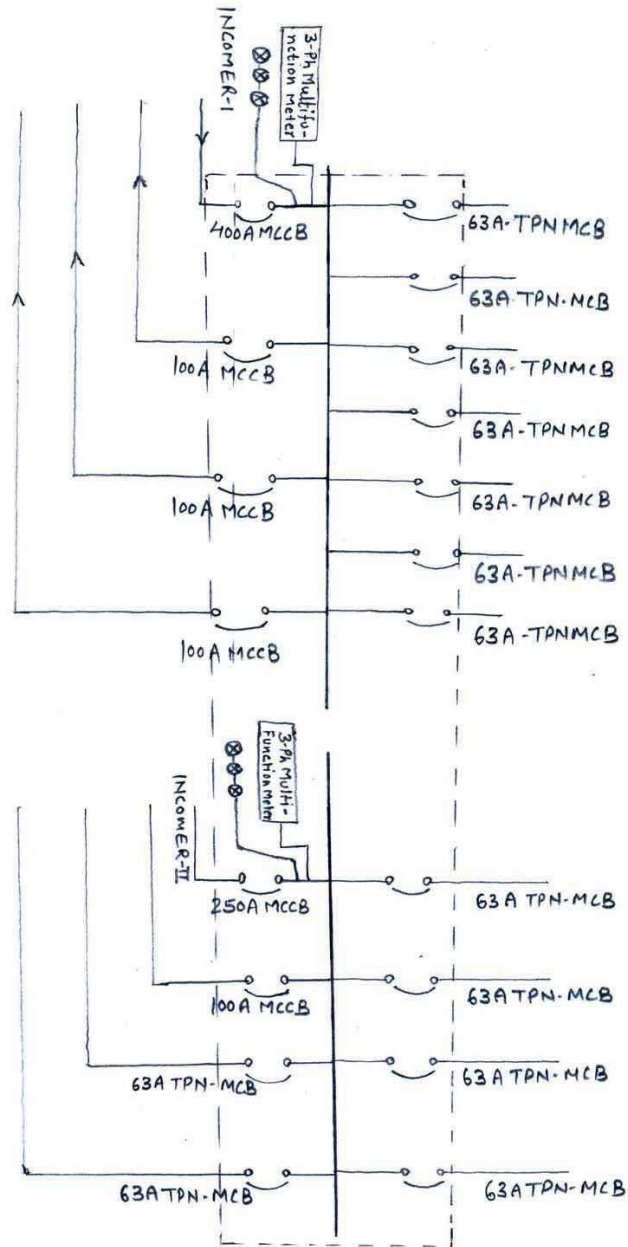

SINGLE LINE DIAGRAM

DRAWN BY:

A.K. SHUKLA

T. A. (Eudt.)



ITEM NO.-(10)

F/P NEAR WORKSHOP

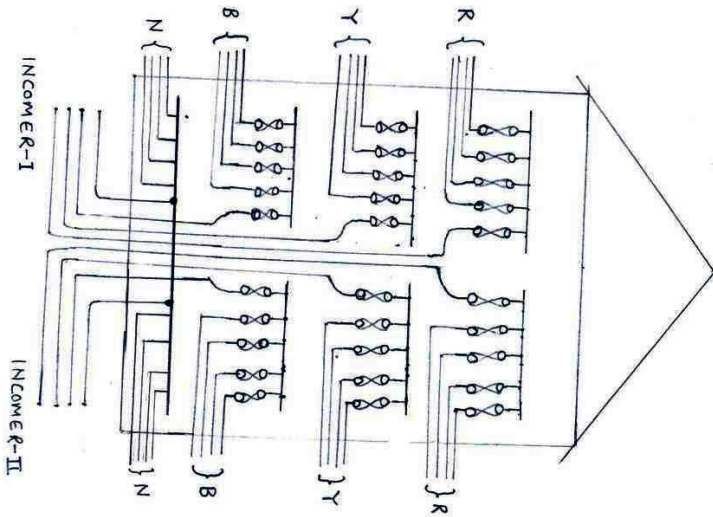
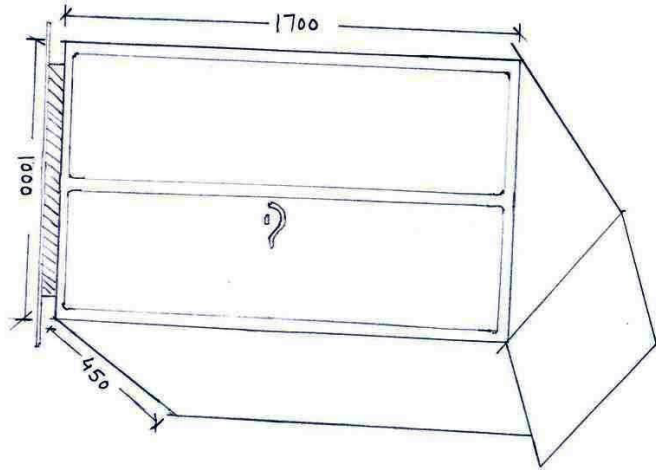

DRAWN BY

A.K. SHUKLA
T.A. (Elect.)

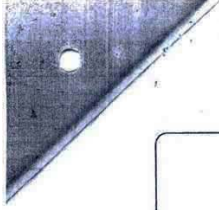

ITEM NO.

11

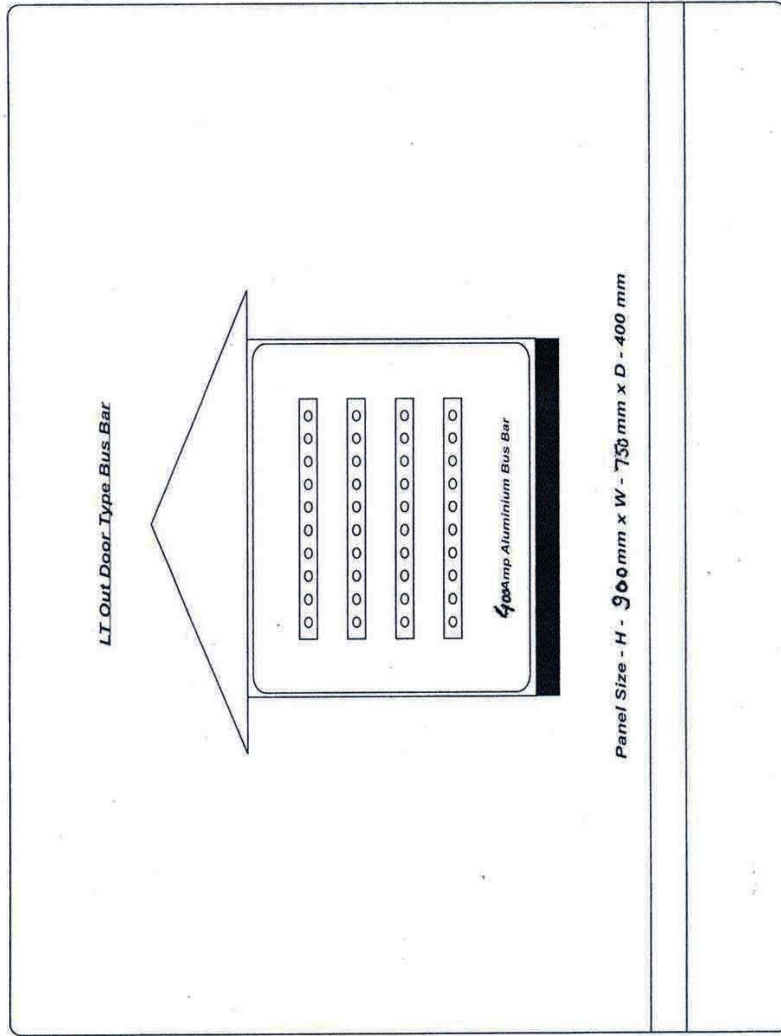

F/P NEAR FARM ROAD

DRAWN BY

(Signature)

A.K. SHUKLA
T.A. (ELECT.)



BUSBAR CHAMBER (S/S)

ITEM NO-12

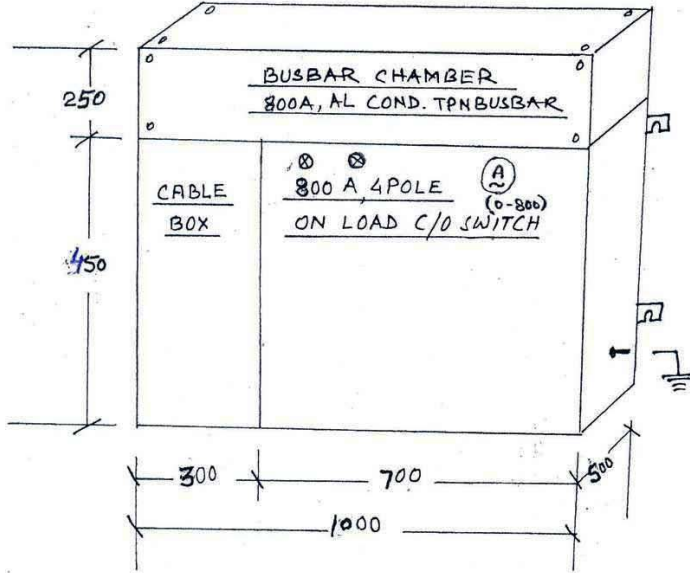

DRAWN BY

A.K. Shukla
13/09/2014

A.K. SHUKLA

T.A. (Elect.)



CENTRAL INSTITUTE OF MEDICINAL AND AROMATIC PLANTS
(Council of scientific & Industrial Research)

Post office CIMAP, Lucknow-226015.

NOTICE INVITING TENDER

Sealed tenders are hereby invited in “Two Bid system” **Technical bid and Financial bid** for the work : **Replacement of the LT panel board of 3rd phase lab. Building, TPN - MCB DB’s panel of the 2nd phase lab. Building, replacement of old cables and installation of additional feeder pillar etc. at CSIR CIMAP Lucknow** from ‘A’ class approved electrical contractors of CPWD, State PWDs. Railway or MES, Public undertakings, UPPCL, registered for carrying out Electrical work from those who have carried out similar works for CSIR, Govt and Semi government organizations or Public Sector Undertaking Institutions etc. Tenderers should have successfully completed at least three work amounting to 40% **(Rs 5.62 Lakhs)** or two works of **50% (Rs. 7.02Lakhs)** or at least one work amounting to **80% (Rs11.23 Lakhs)** value of the estimated cost or above in single contract during the last five year. Tenders will be issued to only those contractors who show the satisfactory work completion certificates and proof of their registration under works contract tax, etc.

The Estimated cost is 14.03 lakhs (based on market rate & CPWD DSR - 2013) and earnest money is Rs28,100.00 (Rupees Twenty eight thousand one hundred only). Tender documents shall be issued during office hours in the office of the Controller of Administration, CIMAP, CENTRAL INSTITUTE OF MEDICINAL AND AROMATIC PLANTS , Post office CIMAP, Lucknow-226015 from 22.10.2014 to 31.10.2014 on cash payment of Rs500.00 (Rupees Five hundred only) Tender papers along with terms and conditions can be down loaded from the Institute web site [www. Cimap.res.in](http://www.Cimap.res.in) and the cost of tender Rs 500.00 to be paid through D.D / Pay order in favor of Director CIMAP, Lucknow along with technical bid. The cost of tender papers is not refundable. Tender will be issued to only those Contractors who show the proof of their experience. Tender shall be received in the office of Controller of Administration, CIMAP, CENTRAL INSTITUTE OF MEDICINAL AND AROMATIC PLANTS , Post office CIMAP, Lucknow-226015 up to 2.30 P.M. on 03.11.2014 and will be opened at 3.30 PM on the same day in the presence of the tenderers present.

The Director, CIMAP reserve the right to accept the tender in part or in whole and reject any or all the tender without assigning any reason.

(Sr. Supt. Engineer)

(Supt. Engineer)

SO (Works)